



OM-223

166 538W

June 2000

Processes



- Gas Metal Arc (MIG) Welding
- Gas Metal Arc-Pulsed Welding
- Flux Cored Arc Welding
- Submerged Arc Welding (452/652 Only)



- Air Carbon Arc Cutting and Gouging (452/652 Only)

Description



Arc Welding Power Source

Cyber Weld

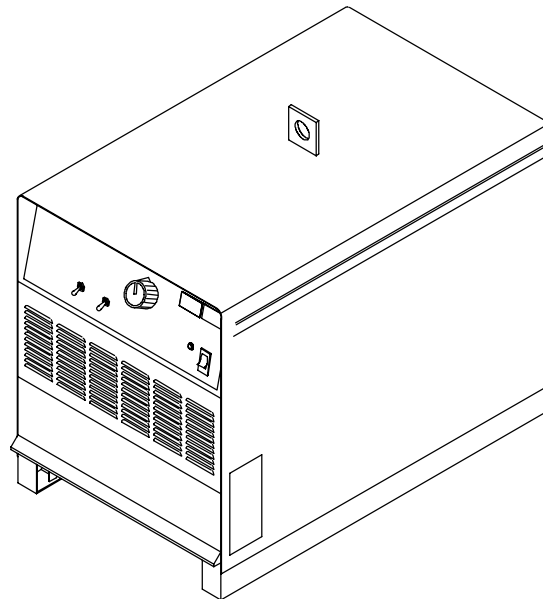

302, 452, and 652 Models

OWNER'S MANUAL

From Hobart to You

Thank you and congratulations on choosing Hobart. Now you can get the job done and get it done right. We know you don't have time to do it any other way.

This Owner's Manual is designed to help you get the most out of your Hobart products. Please take time to read the Safety precautions. They will help you

protect yourself against potential hazards on the worksite. We've made installation and operation quick and easy. With Hobart you can count on years of reliable service with proper maintenance. And if for some reason the unit needs repair, there's a Troubleshooting section that will help you figure out what the problem is. The parts list will then help you to decide which exact part you may need to fix the problem. Warranty and service information for your particular model are also provided.

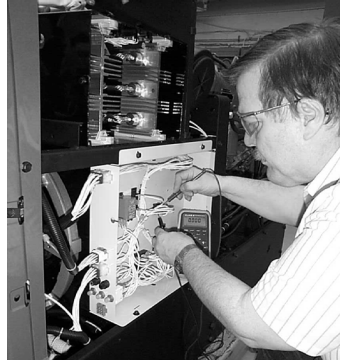

Hobart is registered to the ISO 9001 Quality System Standard.

Hobart Welders manufactures a full line of welders and welding related equipment. For information on other quality Hobart products, contact your local Hobart distributor to receive the latest full line catalog or individual catalog sheets. **To locate your nearest distributor or service agency call 1-877-Hobart1.**



Hobart offers a Technical Manual which provides more detailed service and parts information for your unit. To obtain a Technical Manual, contact your local distributor. Your distributor can also supply you with Welding Process Manuals such as SMAW, GTAW, GMAW, and GMAW-P.

HOBART[®]
WELDING PRODUCTS

TABLE OF CONTENTS

The following terms are used interchangeably throughout this manual:
MIG = GMAW

WARNING

This product, when used for welding or cutting, produces fumes or gases which contain chemicals known to the State of California to cause birth defects and, in some cases, cancer. (California Health & Safety Code Section 25249.5 et seq.)

SECTION 1 – SAFETY PRECAUTIONS	1
1-1. Symbol Usage	1
1-2. Arc Welding Hazards	1
1-3. Additional Symbols for Installation, Operation, and Maintenance	3
1-4. Principal Safety Standards	3
1-5. EMF Information	4
SECTION 1 – CONSIGNES DE SECURITE	5
1-1. Signification des symboles	5
1-2. Dangers relatifs au soudage à l'arc	5
1-3. Dangers supplémentaires en relation avec l'installation, le fonctionnement et la maintenance	7
1-4. Principales normes de sécurité	8
1-5. Information sur les champs électromagnétiques	8
SECTION 2 – DEFINITIONS	9
2-1. General Precautionary Label	9
2-2. Input Connection Label	10
2-3. Electric Shock and Airflow Label	10
2-4. Nameplate Safety Symbols	10
SECTION 3 – INSTALLATION	13
3-1. Specifications	13
3-2. Duty Cycle and Overheating	13
3-4. Selecting a Location	15
3-6. Tipping	16
3-7. 115 VAC Receptacle and Circuit Breakers	16
3-11. Remote 14 Receptacle RC8 and Terminal Strip 1T Connections	18
3-12. Placing Jumper Links and Connecting Input Power	19
SECTION 4 – OPERATION	20
4-1. Controls (Non CE Models)	20
4-2. Controls (CE Models)	20
SECTION 5 – MAINTENANCE & TROUBLESHOOTING	21
5-2. Fuse F1	21
SECTION 6 – ELECTRICAL DIAGRAM	23
SECTION 7 – PARTS LIST	24
OPTIONS AND ACCESSORIES	
WARRANTY	

SECTION 1 – SAFETY PRECAUTIONS - READ BEFORE USING

som _nd_5/97

1-1. Symbol Usage



Means Warning! Watch Out! There are possible hazards with this procedure! The possible hazards are shown in the adjoining symbols.

▲ Marks a special safety message.

☞ Means "Note"; not safety related.



This group of symbols means Warning! Watch Out! possible ELECTRIC SHOCK, MOVING PARTS, and HOT PARTS hazards. Consult symbols and related instructions below for necessary actions to avoid the hazards.

1-2. Arc Welding Hazards

▲ The symbols shown below are used throughout this manual to call attention to and identify possible hazards. When you see the symbol, watch out, and follow the related instructions to avoid the hazard. The safety information given below is only a summary of the more complete safety information found in the Safety Standards listed in Section 1-4. Read and follow all Safety Standards.

▲ Only qualified persons should install, operate, maintain, and repair this unit.

▲ During operation, keep everybody, especially children, away.



ELECTRIC SHOCK can kill.

Touching live electrical parts can cause fatal shocks or severe burns. The electrode and work circuit is electrically live whenever the output is on. The input power circuit and machine internal circuits are also live when power is on. In semiautomatic or automatic wire welding, the wire, wire reel, drive roll housing, and all metal parts touching the welding wire are electrically live. Incorrectly installed or improperly grounded equipment is a hazard.

- Do not touch live electrical parts.
- Wear dry, hole-free insulating gloves and body protection.
- Insulate yourself from work and ground using dry insulating mats or covers big enough to prevent any physical contact with the work or ground.
- Do not use AC output in damp areas, if movement is confined, or if there is a danger of falling.
- Use AC output ONLY if required for the welding process.
- If AC output is required, use remote output control if present on unit.
- Disconnect input power or stop engine before installing or servicing this equipment. Lockout/tagout input power according to OSHA 29 CFR 1910.147 (see Safety Standards).
- Properly install and ground this equipment according to its Owner's Manual and national, state, and local codes.
- Always verify the supply ground – check and be sure that input power cord ground wire is properly connected to ground terminal in disconnect box or that cord plug is connected to a properly grounded receptacle outlet.
- When making input connections, attach proper grounding conductor first – double-check connections.
- Frequently inspect input power cord for damage or bare wiring – replace cord immediately if damaged – bare wiring can kill.
- Turn off all equipment when not in use.
- Do not use worn, damaged, undersized, or poorly spliced cables.
- Do not drape cables over your body.

- If earth grounding of the workpiece is required, ground it directly with a separate cable – do not use work clamp or work cable.
- Do not touch electrode if you are in contact with the work, ground, or another electrode from a different machine.
- Use only well-maintained equipment. Repair or replace damaged parts at once. Maintain unit according to manual.
- Wear a safety harness if working above floor level.
- Keep all panels and covers securely in place.
- Clamp work cable with good metal-to-metal contact to workpiece or worktable as near the weld as practical.
- Insulate work clamp when not connected to workpiece to prevent contact with any metal object.
- Do not connect more than one electrode or work cable to any single weld output terminal.

SIGNIFICANT DC VOLTAGE exists after removal of input power on inverters.

- Turn Off inverter, disconnect input power, and discharge input capacitors according to instructions in Maintenance Section before touching any parts.

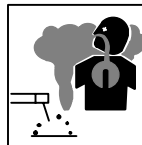

FUMES AND GASES can be hazardous.

Welding produces fumes and gases. Breathing these fumes and gases can be hazardous to your health.

- Keep your head out of the fumes. Do not breathe the fumes.
- If inside, ventilate the area and/or use exhaust at the arc to remove welding fumes and gases.
- If ventilation is poor, use an approved air-supplied respirator.
- Read the Material Safety Data Sheets (MSDSs) and the manufacturer's instructions for metals, consumables, coatings, cleaners, and degreasers.
- Work in a confined space only if it is well ventilated, or while wearing an air-supplied respirator. Always have a trained watchperson nearby. Welding fumes and gases can displace air and lower the oxygen level causing injury or death. Be sure the breathing air is safe.
- Do not weld in locations near degreasing, cleaning, or spraying operations. The heat and rays of the arc can react with vapors to form highly toxic and irritating gases.
- Do not weld on coated metals, such as galvanized, lead, or cadmium plated steel, unless the coating is removed from the weld area, the area is well ventilated, and if necessary, while wearing an air-supplied respirator. The coatings and any metals containing these elements can give off toxic fumes if welded.



ARC RAYS can burn eyes and skin.

Arc rays from the welding process produce intense visible and invisible (ultraviolet and infrared) rays that can burn eyes and skin. Sparks fly off from the weld.

- Wear a welding helmet fitted with a proper shade of filter to protect your face and eyes when welding or watching (see ANSI Z49.1 and Z87.1 listed in Safety Standards).
- Wear approved safety glasses with side shields under your helmet.
- Use protective screens or barriers to protect others from flash and glare; warn others not to watch the arc.
- Wear protective clothing made from durable, flame-resistant material (leather and wool) and foot protection.



WELDING can cause fire or explosion.

Welding on closed containers, such as tanks, drums, or pipes, can cause them to blow up. Sparks can fly off from the welding arc. The flying sparks, hot workpiece, and hot equipment can cause fires and burns. Accidental contact of electrode to metal objects can cause sparks, explosion, overheating, or fire. Check and be sure the area is safe before doing any welding.

- Protect yourself and others from flying sparks and hot metal.
- Do not weld where flying sparks can strike flammable material.
- Remove all flammables within 35 ft (10.7 m) of the welding arc. If this is not possible, tightly cover them with approved covers.
- Be alert that welding sparks and hot materials from welding can easily go through small cracks and openings to adjacent areas.
- Watch for fire, and keep a fire extinguisher nearby.
- Be aware that welding on a ceiling, floor, bulkhead, or partition can cause fire on the hidden side.
- Do not weld on closed containers such as tanks, drums, or pipes, unless they are properly prepared according to AWS F4.1 (see Safety Standards).
- Connect work cable to the work as close to the welding area as practical to prevent welding current from traveling long, possibly unknown paths and causing electric shock and fire hazards.
- Do not use welder to thaw frozen pipes.
- Remove stick electrode from holder or cut off welding wire at contact tip when not in use.
- Wear oil-free protective garments such as leather gloves, heavy shirt, cuffless trousers, high shoes, and a cap.
- Remove any combustibles, such as a butane lighter or matches, from your person before doing any welding.

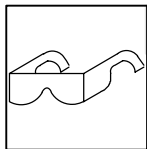

FLYING METAL can injure eyes.

- Welding, chipping, wire brushing, and grinding cause sparks and flying metal. As welds cool, they can throw off slag.
- Wear approved safety glasses with side shields even under your welding helmet.



BUILDUP OF GAS can injure or kill.

- Shut off shielding gas supply when not in use.
- Always ventilate confined spaces or use approved air-supplied respirator.



HOT PARTS can cause severe burns.

- Do not touch hot parts bare handed.
- Allow cooling period before working on gun or torch.

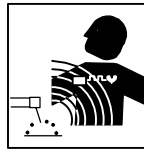

MAGNETIC FIELDS can affect pacemakers.

- Pacemaker wearers keep away.
- Wearers should consult their doctor before going near arc welding, gouging, or spot welding operations.

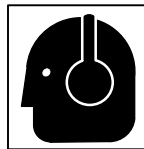

NOISE can damage hearing.

Noise from some processes or equipment can damage hearing.

- Wear approved ear protection if noise level is high.

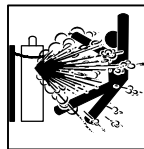

CYLINDERS can explode if damaged.

Shielding gas cylinders contain gas under high pressure. If damaged, a cylinder can explode. Since gas cylinders are normally part of the welding process, be sure to treat them carefully.

- Protect compressed gas cylinders from excessive heat, mechanical shocks, slag, open flames, sparks, and arcs.
- Install cylinders in an upright position by securing to a stationary support or cylinder rack to prevent falling or tipping.
- Keep cylinders away from any welding or other electrical circuits.
- Never drape a welding torch over a gas cylinder.
- Never allow a welding electrode to touch any cylinder.
- Never weld on a pressurized cylinder – explosion will result.
- Use only correct shielding gas cylinders, regulators, hoses, and fittings designed for the specific application; maintain them and associated parts in good condition.
- Turn face away from valve outlet when opening cylinder valve.
- Keep protective cap in place over valve except when cylinder is in use or connected for use.
- Read and follow instructions on compressed gas cylinders, associated equipment, and CGA publication P-1 listed in Safety Standards.

1-3. Additional Symbols for Installation, Operation, and Maintenance



FIRE OR EXPLOSION hazard.

- Do not install or place unit on, over, or near combustible surfaces.
- Do not install unit near flammables.
- Do not overload building wiring – be sure power supply system is properly sized, rated, and protected to handle this unit.



MOVING PARTS can cause injury.

- Keep away from moving parts such as fans.
- Keep all doors, panels, covers, and guards closed and securely in place.



FALLING UNIT can cause injury.

- Use lifting eye to lift unit only, NOT running gear, gas cylinders, or any other accessories.
- Use equipment of adequate capacity to lift and support unit.
- If using lift forks to move unit, be sure forks are long enough to extend beyond opposite side of unit.

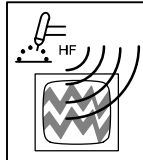

H.F. RADIATION can cause interference.

- High-frequency (H.F.) can interfere with radio navigation, safety services, computers, and communications equipment.
- Have only qualified persons familiar with electronic equipment perform this installation.
- The user is responsible for having a qualified electrician promptly correct any interference problem resulting from the installation.
- If notified by the FCC about interference, stop using the equipment at once.
- Have the installation regularly checked and maintained.
- Keep high-frequency source doors and panels tightly shut, keep spark gaps at correct setting, and use grounding and shielding to minimize the possibility of interference.

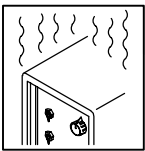

OVERUSE can cause OVERHEATING

- Allow cooling period; follow rated duty cycle.
- Reduce current or reduce duty cycle before starting to weld again.
- Do not block or filter airflow to unit.

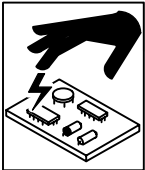

STATIC (ESD) can damage PC boards.

- Put on grounded wrist strap BEFORE handling boards or parts.
- Use proper static-proof bags and boxes to store, move, or ship PC boards.



MOVING PARTS can cause injury.

- Keep away from moving parts.
- Keep away from pinch points such as drive rolls.



WELDING WIRE can cause injury.

- Do not press gun trigger until instructed to do so.
- Do not point gun toward any part of the body, other people, or any metal when threading welding wire.

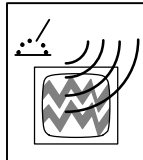

ARC WELDING can cause interference.

- Electromagnetic energy can interfere with sensitive electronic equipment such as computers and computer-driven equipment such as robots.
- Be sure all equipment in the welding area is electromagnetically compatible.
- To reduce possible interference, keep weld cables as short as possible, close together, and down low, such as on the floor.
- Locate welding operation 100 meters from any sensitive electronic equipment.
- Be sure this welding machine is installed and grounded according to this manual.
- If interference still occurs, the user must take extra measures such as moving the welding machine, using shielded cables, using line filters, or shielding the work area.

1-4. Principal Safety Standards

Safety in Welding and Cutting, ANSI Standard Z49.1, from American Welding Society, 550 N.W. LeJeune Rd, Miami FL 33126

Safety and Health Standards, OSHA 29 CFR 1910, from Superintendent of Documents, U.S. Government Printing Office, Washington, D.C. 20402.

Recommended Safe Practices for the Preparation for Welding and Cutting of Containers That Have Held Hazardous Substances, American Welding Society Standard AWS F4.1, from American Welding Society, 550 N.W. LeJeune Rd, Miami, FL 33126

National Electrical Code, NFPA Standard 70, from National Fire Protection Association, Batterymarch Park, Quincy, MA 02269.

Safe Handling of Compressed Gases in Cylinders, CGA Pamphlet P-1, from Compressed Gas Association, 1235 Jefferson Davis Highway, Suite 501, Arlington, VA 22202.

Code for Safety in Welding and Cutting, CSA Standard W117.2, from Canadian Standards Association, Standards Sales, 178 Rexdale Boulevard, Rexdale, Ontario, Canada M9W 1R3.

Safe Practices For Occupation And Educational Eye And Face Protection, ANSI Standard Z87.1, from American National Standards Institute, 1430 Broadway, New York, NY 10018.

Cutting And Welding Processes, NFPA Standard 51B, from National Fire Protection Association, Batterymarch Park, Quincy, MA 02269.

1-5. EMF Information

Considerations About Welding And The Effects Of Low Frequency Electric And Magnetic Fields

Welding current, as it flows through welding cables, will cause electromagnetic fields. There has been and still is some concern about such fields. However, after examining more than 500 studies spanning 17 years of research, a special blue ribbon committee of the National Research Council concluded that: "The body of evidence, in the committee's judgment, has not demonstrated that exposure to power-frequency electric and magnetic fields is a human-health hazard." However, studies are still going forth and evidence continues to be examined. Until the final conclusions of the research are reached, you may wish to minimize your exposure to electromagnetic fields when welding or cutting.

To reduce magnetic fields in the workplace, use the following procedures:

1. Keep cables close together by twisting or taping them.
2. Arrange cables to one side and away from the operator.
3. Do not coil or drape cables around your body.
4. Keep welding power source and cables as far away from operator as practical.
5. Connect work clamp to workpiece as close to the weld as possible.

About Pacemakers:

Pacemaker wearers consult your doctor first. If cleared by your doctor, then following the above procedures is recommended.

1-1. Signification des symboles



Signifie Mise en garde ! Soyez vigilant ! Cette procédure présente des risques de danger ! Ceux-ci sont identifiés par des symboles adjacents aux directives.

▲ Identifie un message de sécurité particulier.

☞ Signifie NOTA ; n'est pas relatif à la sécurité.



Ce groupe de symboles signifie Mise en garde ! Soyez vigilant ! Il y a des risques de danger reliés aux CHOCS ÉLECTRIQUES, aux PIÈCES EN MOUVEMENT et aux PIÈCES CHAUDES. Reportez-vous aux symboles et aux directives ci-dessous afin de connaître les mesures à prendre pour éviter tout danger.

1-2. Dangers relatifs au soudage à l'arc

▲ Les symboles présentés ci-après sont utilisés tout au long du présent manuel pour attirer votre attention et identifier les risques de danger. Lorsque vous voyez un symbole, soyez vigilant et suivez les directives mentionnées afin d'éviter tout danger. Les consignes de sécurité présentées ci-après ne font que résumer l'information contenue dans les normes de sécurité énumérées à la section 1-5. Veuillez lire et respecter toutes ces normes de sécurité.

▲ L'installation, l'utilisation, l'entretien et les réparations ne doivent être confiés qu'à des personnes qualifiées.

▲ Au cours de l'utilisation, tenir toute personne à l'écart et plus particulièrement les enfants.



UN CHOC ÉLECTRIQUE peut tuer.

Un simple contact avec des pièces électriques peut provoquer une électrocution ou des blessures graves. L'électrode et le circuit de soudage sont sous tension dès que l'appareil est sur ON. Le circuit d'entrée et les circuits internes de l'appareil sont également sous tension à ce moment-là. En soudage semi-automatique ou automatique, le fil, le dévidoir, le logement des galets d'entraînement et les pièces métalliques en contact avec le fil de soudage sont sous tension. Des matériels mal installés ou mal mis à la terre présentent un danger.

- Ne jamais toucher les pièces électriques sous tension.
- Porter des gants et des vêtements de protection secs ne comportant pas de trous.
- S'isoler de la pièce et de la terre au moyen de tapis ou d'autres moyens isolants suffisamment grands pour empêcher le contact physique éventuel avec la pièce ou la terre.
- Ne pas se servir de source électrique à courant électrique dans les zones humides, dans les endroits confinés ou là où on risque de tomber.
- Se servir d'une source électrique à courant électrique UNIQUEMENT si le procédé de soudage le demande.
- Si l'utilisation d'une source électrique à courant électrique s'avère nécessaire, se servir de la fonction de télécommande si l'appareil en est équipé.
- Couper l'alimentation ou arrêter le moteur avant de procéder à l'installation, à la réparation ou à l'entretien de l'appareil. Déverrouiller l'alimentation selon la norme OSHA 29 CFR 1910.147 (voir normes de sécurité).
- Installer et mettre à la terre correctement cet appareil conformément à son manuel d'utilisation et aux codes nationaux, provinciaux et municipaux.
- Toujours vérifier la terre du cordon d'alimentation – Vérifier et s'assurer que le fil de terre du cordon d'alimentation est bien raccordé à la borne de terre du sectionneur ou que la fiche du cordon est raccordée à une prise correctement mise à la terre.
- En effectuant les raccordements d'entrée fixer d'abord le conducteur de mise à la terre approprié et contre-vérifier les connexions.
- Vérifier fréquemment le cordon d'alimentation pour voir s'il n'est pas endommagé ou dénudé – remplacer le cordon immédiatement s'il est endommagé – un câble dénudé peut provoquer une électrocution.
- Mettre l'appareil hors tension quand on ne l'utilise pas.
- Ne pas utiliser des câbles usés, endommagés, de grosseur insuffisante ou mal épissés.
- Ne pas enrôler les câbles autour du corps.
- Si la pièce soudée doit être mise à la terre, le faire directement avec un câble distinct – ne pas utiliser le connecteur de pièce ou le câble de retour.
- Ne pas toucher l'électrode quand on est en contact avec la pièce, la terre ou une électrode provenant d'une autre machine.

- N'utiliser qu'un matériel en bon état. Réparer ou remplacer sur-le-champ les pièces endommagées. Entretien l'appareil conformément à ce manuel.
- Porter un harnais de sécurité quand on travaille en hauteur.
- Maintenir solidement en place tous les panneaux et capots.
- Fixer le câble de retour de façon à obtenir un bon contact métal-métal avec la pièce à souder ou la table de travail, le plus près possible de la soudure.
- Isoler la pince de masse quand pas mis à la pièce pour éviter le contact avec tout objet métallique.

Il y a DU COURANT CONTINU IMPORTANT dans les convertisseurs après la suppression de l'alimentation électrique.

- Arrêter les convertisseurs, débrancher le courant électrique, et décharger les condensateurs d'alimentation selon les instructions indiquées dans la partie entretien avant de toucher les pièces.

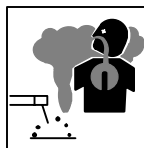

LES FUMÉES ET LES GAZ peuvent être dangereux.

Le soudage génère des fumées et des gaz. Leur inhalation peut être dangereuse pour votre santé.

- Eloigner votre tête des fumées. Ne pas respirer les fumées.
- A l'intérieur, ventiler la zone et/ou utiliser un échappement au niveau de l'arc pour l'évacuation des fumées et des gaz de soudage.
- Si la ventilation est insuffisante, utiliser un respirateur à alimentation d'air homologué.
- Lire les spécifications de sécurité des matériaux (MSDSs) et les instructions du fabricant concernant les métaux, les consommables, les revêtements, les nettoyants et les dégraissateurs.
- Travailler dans un espace fermé seulement s'il est bien ventilé ou en portant un respirateur à alimentation d'air. Demander toujours à un surveillant dûment formé de se tenir à proximité. Des fumées et des gaz de soudage peuvent déplacer l'air et abaisser le niveau d'oxygène provoquant des blessures ou des accidents mortels. S'assurer que l'air de respiration ne présente aucun danger.
- Ne pas souder dans des endroits situés à proximité d'opérations de dégraissage, de nettoyage ou de pulvérisation. La chaleur et les rayons de l'arc peuvent réagir en présence de vapeurs et former des gaz hautement toxiques et irritants.
- Ne pas souder des métaux munis d'un revêtement, tels que l'acier galvanisé, plaqué en plomb ou au cadmium à moins que le revêtement n'ait été enlevé dans la zone de soudure, que l'endroit soit bien ventilé, et si nécessaire, en portant un respirateur à alimentation d'air. Les revêtements et tous les métaux renfermant ces éléments peuvent dégager des fumées toxiques en cas de soudage.



LES RAYONS DE L'ARC peuvent provoquer des brûlures dans les yeux et sur la peau.

Le rayonnement de l'arc du procédé de soudage génère des rayons visibles et invisibles intenses (ultraviolets et infrarouges) susceptibles de provoquer des brûlures dans les yeux et sur la peau. Des étincelles sont projetées pendant le soudage.

- Porter un casque de soudage muni d'un écran de filtre approprié pour protéger votre visage et vos yeux pendant le soudage ou pour regarder (voir ANSI Z49.1 et Z87.1 énuméré dans les normes de sécurité).
- Porter des protections approuvés pour les oreilles si le niveau sonore est trop élevé.
- Utiliser des écrans ou des barrières pour protéger des tiers de l'éclair et de l'éblouissement; demander aux autres personnes de ne pas regarder l'arc.
- Porter des vêtements de protection constitué dans une matière durable, résistant au feu (cuir ou laine) et une protection des pieds.



LE SOUDAGE peut provoquer un incendie ou une explosion.

Le soudage effectué sur des conteneurs fermés tels que des réservoirs, tambours ou des conduites peut provoquer leur éclatement. Des étincelles peuvent être projetées de l'arc de soudure. La projection d'étincelles, des pièces chaudes et des équipements chauds peut provoquer des incendies et des brûlures. Le contact accidentel de l'électrode avec des objets métalliques peut provoquer des étincelles, une explosion, un surchauffement ou un incendie. Avant de commencer le soudage, vérifier et s'assurer que l'endroit ne présente pas de danger.

- Se protéger et d'autres personnes de la projection d'étincelles et de métal chaud.
- Ne pas souder dans un endroit là où des étincelles peuvent tomber sur des substances inflammables.
- Déplacer toutes les substances inflammables à une distance de 10,7 m de l'arc de soudage. En cas d'impossibilité les recouvrir soigneusement avec des protections homologués.
- Des étincelles et des matériaux chauds du soudage peuvent facilement passer dans d'autres zones en traversant de petites fissures et des ouvertures.
- Surveiller tout déclenchement d'incendie et tenir un extincteur à proximité.
- Le soudage effectué sur un plafond, plancher, paroi ou séparation peut déclencher un incendie de l'autre côté.
- Ne pas effectuer le soudage sur des conteneurs fermés tels que des réservoirs, tambours, ou conduites, à moins qu'ils n'aient été préparés correctement conformément à AWS F4.1 (voir les normes de sécurité).
- Brancher le câble sur la pièce le plus près possible de la zone de soudage pour éviter le transport du courant sur une longue distance par des chemins inconnus éventuels en provoquant des risques d'électrocution et d'incendie.
- Ne pas utiliser le poste de soudage pour décongeler des conduites gelées.
- En cas de non utilisation, enlever la bague d'électrode du porte-électrode ou couper le fil à la pointe de contact.
- Porter des vêtements de protection dépourvus d'huile tels que des gants en cuir, une chemise en matériau lourd, des pantalons sans revers, des chaussures hautes et un couvre chef.
- Avant de souder, retirer toute substance combustible de vos poches telles qu'un allumeur au butane ou des allumettes.

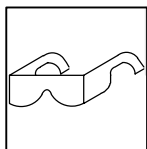

DES PARTICULES VOLANTES peuvent blesser les yeux.

- Le soudage, l'écaillage, le passage de la pièce à la brosse en fil de fer, et le meulage génèrent des étincelles et des particules métalliques volantes. Pendant la période de refroidissement des soudures, elles risquent de projeter du laitier.
- Porter des lunettes de sécurité avec écrans latéraux ou un écran facial.



LES ACCUMULATIONS DE GAZ risquent de provoquer des blessures ou même la mort.

- Fermer l'alimentation du gaz protecteur en cas de non utilisation.
- Veiller toujours à bien aérer les espaces confinés ou se servir d'un respirateur d'adduction d'air homologué.



DES PIÈCES CHAUDES peuvent provoquer des brûlures graves.

- Ne pas toucher des parties chaudes à mains nues
- Prévoir une période de refroidissement avant d'utiliser le pistolet ou la torche.

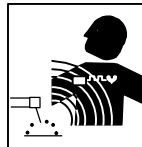

LES CHAMPS MAGNÉTIQUES peuvent affecter les stimulateurs cardiaques.

- Porteurs de stimulateur cardiaque, restez à distance.
- Les porteurs d'un stimulateur cardiaque doivent d'abord consulter leur médecin avant de s'approcher des opérations de soudage à l'arc, de gougeage ou de soudage par points.

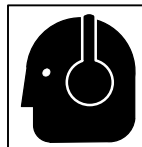

LE BRUIT peut affecter l'ouïe.

Le bruit des processus et des équipements peut affecter l'ouïe.

- Porter des protections approuvés pour les oreilles si le niveau sonore est trop élevé.

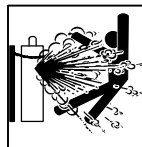

Si des BOUTEILLES sont endommagées, elles pourront exploser.

Des bouteilles de gaz protecteur contiennent du gaz sous haute pression. Si une bouteille est endommagée, elle peut exploser. Du fait que les bouteilles de gaz font normalement partie du procédé de soudage, les manipuler avec précaution.

- Protéger les bouteilles de gaz comprimé d'une chaleur excessive, des chocs mécaniques, du laitier, des flammes ouvertes, des étincelles et des arcs.
- Placer les bouteilles debout en les fixant dans un support stationnaire ou dans un porte-bouteilles pour les empêcher de tomber ou de se renverser.
- Tenir les bouteilles éloignées des circuits de soudage ou autres circuits électriques.
- Ne jamais placer une torche de soudage sur une bouteille à gaz.
- Une électrode de soudage ne doit jamais entrer en contact avec une bouteille.
- Ne jamais souder une bouteille pressurisée – risque d'explosion.
- Utiliser seulement des bouteilles de gaz protecteur, régulateurs, tuyaux et raccords convenables pour cette application spécifique; les maintenir ainsi que les éléments associés en bon état.
- Ne pas tenir la tête en face de la sortie en ouvrant la soupape de la bouteille.
- Maintenir le chapeau de protection sur la soupape, sauf en cas d'utilisation ou de branchement de la bouteille.
- Lire et suivre les instructions concernant les bouteilles de gaz comprimé, les équipements associés et les publications P-1 CGA énumérées dans les normes de sécurité.

1-3. Dangers supplémentaires en relation avec l'installation, le fonctionnement et la maintenance



Risque D'INCENDIE OU D'EXPLOSION.

- Ne pas placer l'appareil sur, au-dessus ou à proximité de surfaces inflammables.
- Ne pas installer l'appareil à proximité de produits inflammables
- Ne pas surcharger l'installation électrique – s'assurer que l'alimentation est correctement dimensionnée et protégé avant de mettre l'appareil en service.



LA CHUTE DE L'APPAREIL peut blesser.

- Utiliser l'anneau de levage uniquement pour soulever l'appareil, NON PAS les chariot, les bouteilles de gaz ou tout autre accessoire.
- Utiliser un engin d'une capacité appropriée pour soulever l'appareil.
- En utilisant des fourches de levage pour déplacer l'unité, s'assurer que les fourches sont suffisamment longues pour dépasser du côté opposé de l'appareil.

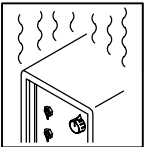

L'EMPLOI EXCESSIF peut SURCHAUFFER L'ÉQUIPEMENT.

- Prévoir une période de refroidissement, respecter le cycle opératoire nominal.
- Réduire le courant ou le cycle opératoire avant de recommencer le soudage.
- Ne pas obstruer les passages d'air du poste.

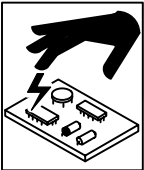

LES CHARGES ÉLECTROSTATIQUES peuvent endommager les circuits imprimés.

- Établir la connexion avec la barrette de terre avant de manipuler des cartes ou des pièces.
- Utiliser des pochettes et des boîtes antistatiques pour stocker, déplacer ou expédier des cartes de circuits imprimés.



DES ORGANES MOBILES peuvent provoquer des blessures.

- Ne pas s'approcher des organes mobiles.
- Ne pas s'approcher des points de coincement tels que des rouleaux de commande.



LES FILS DE SOUDAGE peuvent provoquer des blessures.

- Ne pas appuyer sur la gachette avant d'en avoir reçu l'instruction.
- Ne pas diriger le pistolet vers soi, d'autres personnes ou toute pièce mécanique en engageant le fil de soudage.



DES ORGANES MOBILES peuvent provoquer des blessures.

- Rester à l'écart des organes mobiles comme le ventilateur.
- Maintenir fermés et fixement en place les portes, panneaux, recouvrements et dispositifs de protection.

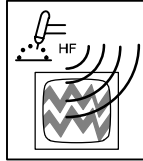

LE RAYONNEMENT HAUTE FRÉQUENCE (H.F.) risque de provoquer des interférences.

- Le rayonnement haute fréquence peut provoquer des interférences avec les équipements de radio-navigation et de communication, les services de sécurité et les ordinateurs.
- Demander seulement à des personnes qualifiées familiarisées avec des équipements électroniques de faire fonctionner l'installation.
- L'utilisateur est tenu de faire corriger rapidement par un électricien qualifié les interférences résultant de l'installation.
- Si le FCC signale des interférences, arrêter immédiatement l'appareil.
- Effectuer régulièrement le contrôle et l'entretien de l'installation.
- Maintenir soigneusement fermés les portes et les panneaux des sources de haute fréquence, maintenir les éclateurs à une distance correcte et utiliser une terre et un blindage pour réduire les interférences éventuelles.

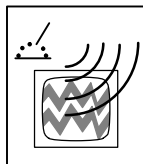

LE SOUDAGE À L'ARC risque de provoquer des interférences.

- L'énergie électromagnétique risque de provoquer des interférences pour l'équipement électronique sensible tel que les ordinateurs et l'équipement commandé par ordinateur tel que les robots.
- Veiller à ce que tout l'équipement de la zone de soudage soit compatible électromagnétiquement.
- Pour réduire la possibilité d'interférence, maintenir les câbles de soudage aussi courts que possible, les grouper, et les poser aussi bas que possible (ex. par terre).
- Veiller à souder à une distance de 100 mètres de tout équipement électronique sensible.
- Veiller à ce que ce poste de soudage soit posé et mis à la terre conformément à ce mode d'emploi.
- En cas d'interférences après avoir pris les mesures précédentes, il incombe à l'utilisateur de prendre des mesures supplémentaires telles que le déplacement du poste, l'utilisation de câbles blindés, l'utilisation de filtres de ligne ou la pose de protecteurs dans la zone de travail.

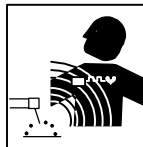

LES CHAMPS MAGNÉTIQUES peuvent affecter les stimulateurs cardiaques.

- Porteurs de stimulateur cardiaque, restez à distance.
- Les porteurs d'un stimulateur cardiaque doivent d'abord consulter leur médecin avant de s'approcher des opérations de soudage à l'arc, de gougeage ou de soudage par points.

1-4. Principales normes de sécurité

Safety in Welding and Cutting, norme ANSI Z49.1, de l'American Welding Society, 550 N.W. Lejeune Rd, Miami FL 33126

Safety and Health Standards, OSHA 29 CFR 1910, du Superintendent of Documents, U.S. Government Printing Office, Washington, D.C. 20402.

Recommended Safe Practice for the Preparation for Welding and Cutting of Containers That Have Held Hazardous Substances, norme AWS F4.1, de l'American Welding Society, 550 N.W. Lejeune Rd, Miami FL 33126

National Electrical Code, NFPA Standard 70, de la National Fire Protection Association, Batterymarch Park, Quincy, MA 02269.

Safe Handling of Compressed Gases in Cylinders, CGA Pamphlet P-1, de la Compressed Gas Association, 1235 Jefferson Davis Highway, Suite 501, Arlington, VA 22202.

Règles de sécurité en soudage, coupage et procédés connexes, norme CSA W117.2, de l'Association canadienne de normalisation, vente de normes, 178 Rexdale Boulevard, Rexdale (Ontario) Canada M9W 1R3.

Safe Practices For Occupation And Educational Eye And Face Protection, norme ANSI Z87.1, de l'American National Standards Institute, 1430 Broadway, New York, NY 10018.

Cutting and Welding Processes, norme NFPA 51B, de la National Fire Protection Association, Batterymarch Park, Quincy, MA 02269.

1-5. Information sur les champs électromagnétiques

Données sur le soudage électrique et sur les effets, pour l'organisme, des champs magnétiques basse fréquence

L'extrait suivant est tiré des conclusions générales du document intitulé *Biological Effects of Power Frequency Electric & Magnetic Fields – Background Paper, OTA-BP-E-53 (Washington DC : U.S. Government Printing Office, mai 1989)*, publié par le Office of Technology Assessment du Congrès américain : «... il existe maintenant d'abondantes données scientifiques compilées à la suite d'expériences sur la cellule ou d'études sur des animaux et des humains, qui montrent clairement que les champs électromagnétiques basse fréquence peuvent avoir des effets sur l'organisme et même y produire des transformations. Même s'il s'agit de travaux de très grande qualité, les résultats sont complexes. Cette démarche scientifique ne nous permet pas d'établir un tableau d'ensemble cohérent. Pire encore, elle ne nous permet pas de tirer des conclusions finales concernant les risques éventuels, ni d'offrir des conseils sur les mesures à prendre pour réduire sinon éliminer les risques éventuels». (Traduction libre)

Afin de réduire les champs électromagnétiques dans l'environnement de travail, respecter les consignes suivantes :

- 1 Garder les câbles ensemble en les torsadant ou en les attachant avec du ruban adhésif.
- 2 Mettre tous les câbles du côté opposé de l'opérateur.
- 3 Ne pas courber pas et ne pas entourer pas les câbles autour de vous.
- 4 Garder le poste de soudage et les câbles le plus loin possible de vous.
- 5 Relier la pince de masse le plus près possible de la zone de soudure.

Consignes relatives aux stimulateurs cardiaques :

Les consignes mentionnées précédemment font partie de celles destinées aux personnes ayant recours à un stimulateur cardiaque. Veuillez consulter votre médecin pour obtenir plus de détails.

SECTION 2 – DEFINITIONS

2-1. General Precautionary Label

1/96

Warning! Watch Out! There are possible hazards as shown by the symbols.

- 1 Electric shock from welding electrode or wiring can kill.
 - 1.1 Wear dry insulating gloves. Do not touch electrode with bare hand. Do not wear wet or damaged gloves.
 - 1.2 Protect yourself from electric shock by insulating yourself from work and ground.
 - 1.3 Disconnect input plug or power before working on machine.
- 2 Breathing welding fumes can be hazardous to your health.
 - 2.1 Keep your head out of the fumes.
 - 2.2 Use forced ventilation or local exhaust to remove the fumes.
 - 2.3 Use ventilating fan to remove fumes.
- 3 Welding sparks can cause explosion or fire.
 - 3.1 Keep flammables away from welding. Do not weld near flammables.
 - 3.2 Welding sparks can cause fires. Have a fire extinguisher nearby, and have a watchperson ready to use it.
 - 3.3 Do not weld on drums or any closed containers.
- 4 Arc rays can burn eyes and injure skin.
 - 4.1 Wear hat and safety glasses. Use ear protection and button shirt collar. Use welding helmet with correct shade of filter. Wear complete body protection.
- 5 Become trained and read the instructions before working on the machine or welding.
- 6 Do not remove or paint over (cover) the label.

S-176 254-A

2-2. Input Connection Label

1/96

- Warning! Watch Out! There are possible hazards as shown by the symbols.
- Electric shock from wiring can kill.
- Disconnect input plug or power before working on machine.
- Read the Owner's Manual before working on this machine.
- Consult rating label for input power requirements, and check power available at the job site – they must match.
- Read Owner's Manual and inside labels for connection points and procedures.
- Move jumper links as shown on inside label to match voltage at job site.
- Having a loop of extra length, connect grounding conductor first.
- Connect line input conductors as shown on inside label – double-check all connections, jumper link positions, and input voltage before applying power.

2-3. Electric Shock And Airflow Label

- Warning! Watch Out! There are possible hazards as shown by the symbols.
- Electric shock from wiring and exposed weld terminals can kill.
- Close door before turning on unit.

1/96

2-4. Nameplate Safety Symbols

- Warning! Watch Out! There are possible hazards as shown by the symbols.
- Electric shock from welding electrode or wiring can kill.
- Sparks from arcing electrode can cause explosion or fire – disconnect cable for process not in use.
- Read Owner's Manual for connection procedures.
- Electric shock from wiring can kill.
- Disconnect input power before working on unit or making terminal strip connections.

Nameplate D-179 389

2-5. Manufacturer's Rating Labels For CE Products

EN 60974-1

	---	100A/10V		300A/32V	
		X			100%
S	$U_0 = 43V$	I_2			300A
		U_2			29V

	U_1	V	I_1	A			
	380V						27A
	400V						25A
	440V						23A
	50 Hz		S_1				17.7kVA
			IP 21M				

S-174 346

EN 60974-1

	---	100A/10V		450A/38V	
		X			100%
S	$U_0 = 48V$	I_2			450A
		U_2			36.5V

	U_1	V	I_1	A			
	380V						39A
	400V						37A
	440V						33A
	50 Hz		S_1				24.9kVA
			IP 21M				

S-174 347

EN 60974-1

	---	100A/10V		650A/44V	
		X			100%
S	$U_0 = 54V$	I_2			650A
		U_2			44V













	U_1	V	I_1	A			
	380V						58A
	400V						54A
	440V						50A
	50 Hz		S_1				38.4kVA
			IP 21M				

S-174 348

Match label to one on unit. See Section 3-4.

2-6. Symbols And Definitions

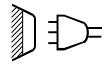
Note  Some symbols are found only on CE products.

A	Amperes		Voltage Control/ Panel		Gas Metal Arc Welding (GMAW)		Temperature
	Output		Circuit Breaker		Remote		On
	Positive High Inductance Weld Output Terminal		Positive Low Inductance Weld Output Terminal	—	Negative Weld Output Terminal		Input
V	Volts	○	Off	o o	Wire Feed		Protective Earth (Ground)
U₀	Rated No Load Voltage (Average)	U₁	Primary Voltage	U₂	Conventional Load Voltage		Line Connection
I₁	Primary Current	I₂	Rated Welding Current	X	Duty Cycle		Three-Phase Transformer Rectifier
IP	Degree Of Protection	~	Alternating Current	S₁	KVA		Direct Current
%	Percent						

SECTION 3 – INSTALLATION



3-1. Specifications

Model	Rated Welding Output	Voltage Range DC	Max OCV DC	IP Rating	Amperes Input at Rated Load Output, 50 or 60 Hz, Three-Phase							KVA	KW
					200 V	230 V	380 V	400 V	440 V	460 V	575 V		
300 Amp	300 A @ 32 (29) Volts DC, 100% Duty Cycle	10 – 32	42	21M	48 3.7*	42 3.2*	27 1.8*	25 1.7*	23 1.6*	21 1.6*	17 1.3*	16.9 1.26*	12.9 0.21*
450 Amp	450 A @ 38 (36.5) Volts DC, 100% Duty Cycle	10 – 38	48	21M	72 3.2*	63 2.7*	39 2.6*	37 2.2*	33 2.1*	32 1.4*	25 1.1*	25.1 1.09*	21.1 0.26*
650 Amp	650 A @ 44 Volts DC, 100% Duty Cycle	10 – 44	54	21M	--	96 3.2*	58 3.3*	54 3.0*	50 2.8*	48 1.6*	38 1.3*	38.2 1.26*	34.2 0.35*

*While idling

() Indicates specification differences for CE models

3-2. Duty Cycle And Overheating

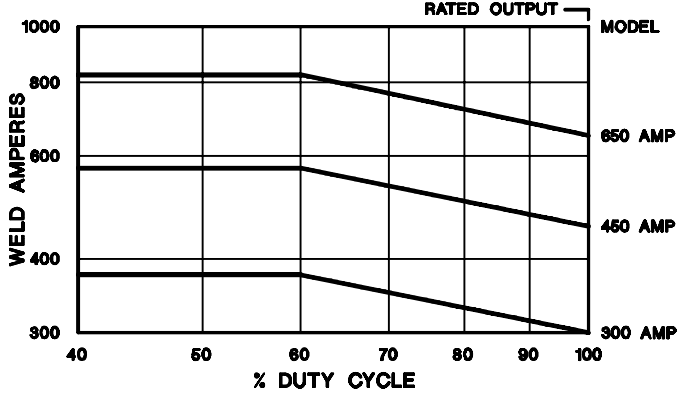

100% Duty Cycle

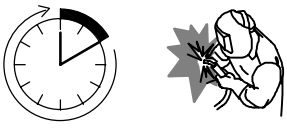

Continuous Welding

Duty Cycle is percentage of 10 minutes that unit can weld at rated load without overheating.

If unit overheats, thermostat(s) opens, output stops, and cooling fan runs. Wait fifteen minutes for unit to cool. Reduce amperage or duty cycle before welding.

▲ Exceeding duty cycle can damage unit and void warranty.

Overheating









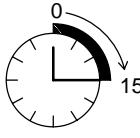





Minutes





OR
Reduce Duty Cycle





duty1 4/95 / SA-168 918

3-3. Volt-Ampere Curves

Volt-ampere curves show minimum and maximum voltage and amperage output capabilities of unit. Curves of other settings fall between curves shown.

A. 300 Amp Model

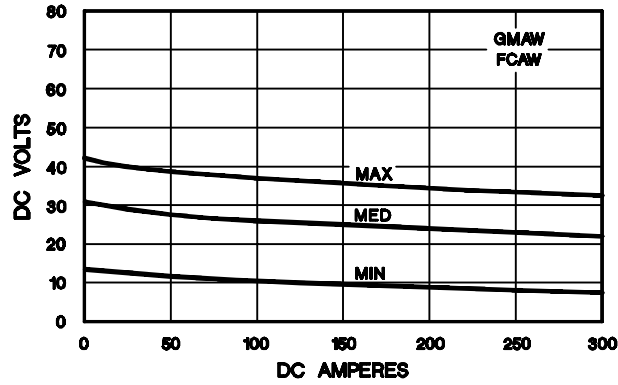

B. 450 Amp Model

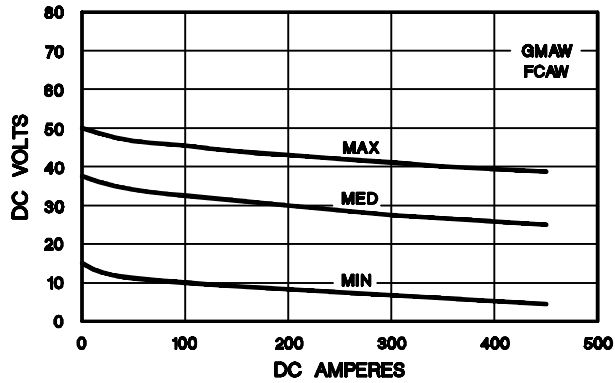

C. 650 Amp Model

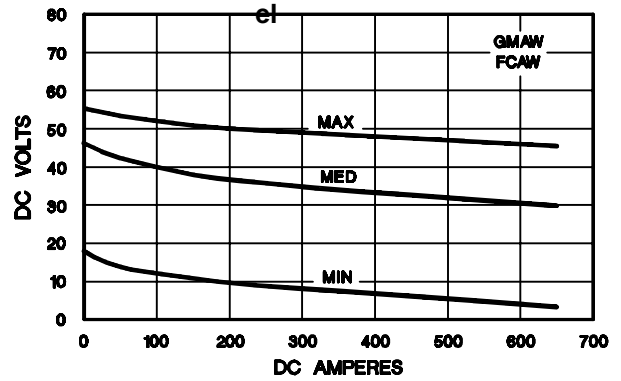

va_curve1 - 4/95 - ST-171 224 / ST-171 225 / ST-171 226

3-4. Selecting A Location



Movement

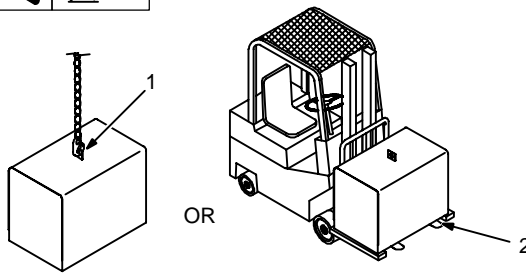

1 Lifting Eye
2 Lifting Forks
Use lifting eye or lifting forks to move unit.

If using lifting forks, extend forks beyond opposite side of unit.

3 Rating Label (Non CE Models Only)

Use rating label to determine input power needs. Label located under front access door.

4 Plate Label (CE Models Only)
Label located under front access door.

5 Rating Label (CE Models Only)

Use rating label to determine input power needs. Label located on rear access door (see Section 2-5).

6 Line Disconnect Device

Locate unit near correct input power supply.

▲ **Special installation may be required where gasoline or volatile liquids are present – see NEC Article 511 or CEC Section 20.**

Location And Airflow

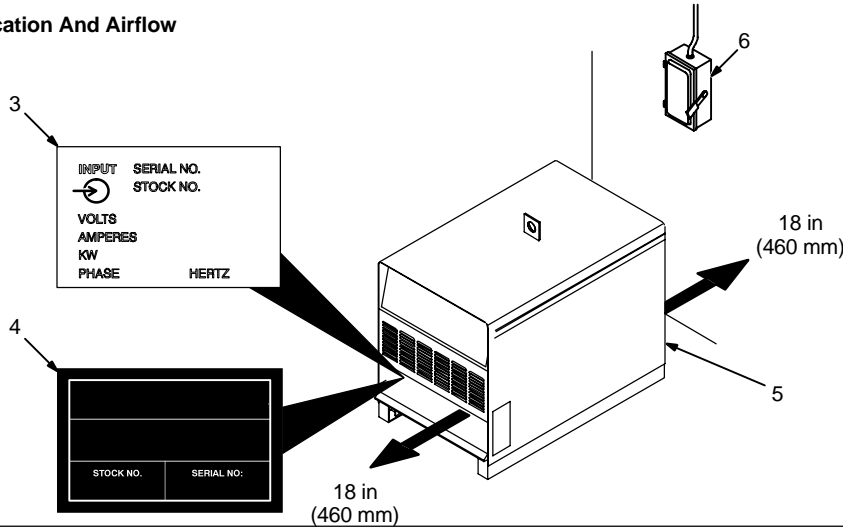

Ref. ST-800 453-A

3-5. Dimensions And Weights

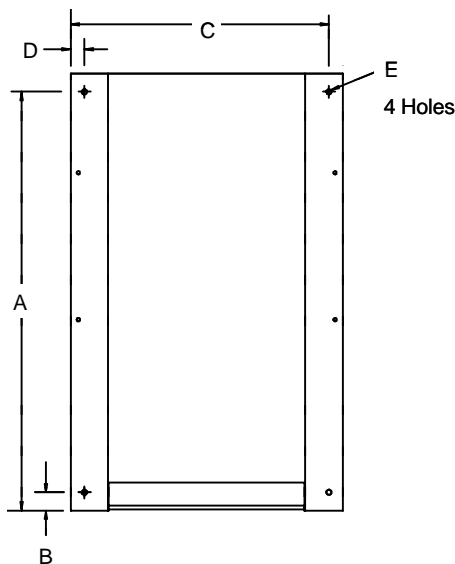

Ref. ST-153 556-A

Dimensions

Height	27-1/4 in (692 mm)
Width	22-1/4 in (565 mm)
Depth*	35-3/4 in (908 mm)
A**	35 in (889 mm)
B***	1-1/4 in (32 mm)
C	21 in (533 mm)
D	1-3/16 in (30 mm)
E	7/16 in (11 mm) Dia
*300 Amp Model = 28-1/4 in (718 mm)	
**300 Amp Model = 27-1/2 in (699 mm)	
***300 Amp Model = 3/4 in (19 mm)	

Weight

300 Amp	323 lb (147 kg)
450 Amp	384 lb (174 kg)
650 Amp	472 lb (214 kg)

3-6. Tipping

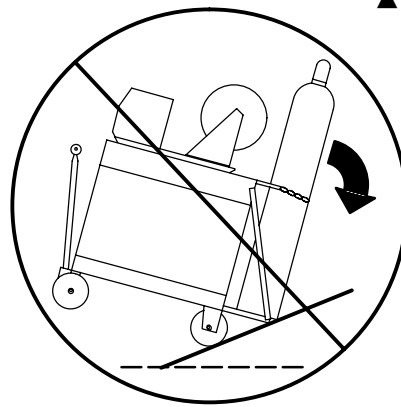
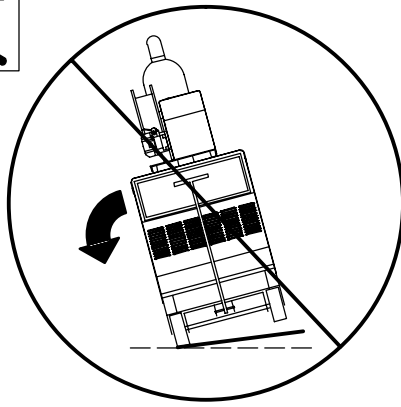

▲ Be careful when placing or moving unit over uneven surfaces.

3-7. 115 VAC Receptacle And Circuit Breakers

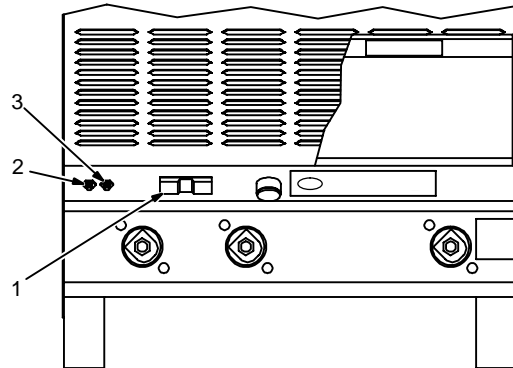

▲ Turn Off power before connecting to receptacle.

- 1 115 V 15 A AC Receptacle RC9

Power is shared between RC9 and Remote 14 receptacle RC8 or terminal strip 1T (see Section 3-11).

- 2 Circuit Breaker CB1
- 3 Circuit Breaker CB2

CB1 protects 115 volts ac portion of RC8, 1T, and RC9 from overload.

CB2 protects 24 volts ac portion of RC8 and 1T from overload.

Press button to reset breaker.

Ref. ST-800 452-B

3-8. Weld Output Terminals And Selecting Cable Sizes

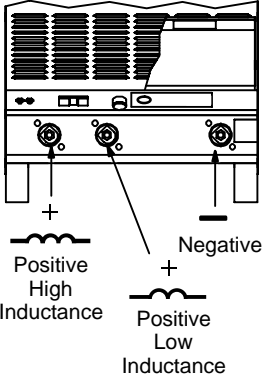

<p>Turn Off power before connecting to weld output terminals.</p> 	Welding Amperes	Total Cable (Copper) Length In Weld Circuit Not Exceeding							
		100 ft (30 m) Or Less		150 ft (45 m)	200 ft (60 m)	250 ft (70 m)	300 ft (90 m)	350 ft (105 m)	400 ft (120 m)
		10 – 60% Duty Cycle	60 – 100% Duty Cycle	10 – 100% Duty Cycle					
100	4	4	4	3	2	1	1/0	1/0	
150	3	3	2	1	1/0	2/0	3/0	3/0	
200	3	2	1	1/0	2/0	3/0	4/0	4/0	
250	2	1	1/0	2/0	3/0	4/0	2-2/0	2-2/0	
300	1	1/0	2/0	3/0	4/0	2-2/0	2-3/0	2-3/0	
350	1/0	2/0	3/0	4/0	2-2/0	2-3/0	2-3/0	2-4/0	
400	1/0	2/0	3/0	4/0	2-2/0	2-3/0	2-4/0	2-4/0	
500	2/0	3/0	4/0	2-2/0	2-3/0	2-4/0	3-3/0	3-3/0	
600	3/0	4/0	2-2/0	2-3/0	2-4/0	3-3/0	3-4/0	3-4/0	
700	4/0	2-2/0	2-3/0	2-4/0	3-3/0	3-4/0	3-4/0	4-4/0	

*Weld cable size (AWG) is based on either a 4 volts or less drop or a current density of at least 300 circular mils per ampere. Contact your distributor for the mm² equivalent weld cable sizes.

S-0007-E

3-9. Electrical Service Guide

60 Hertz Models	300 Amp Model				450 Amp Model				650 Amp Model			
Input Voltage	200	230	460	575	200	230	460	575	230	460	575	
Input Amperes At Rated Output	48	42	21	17	72	63	32	25	96	48	38	
Max Recommended Standard Fuse Rating In Amperes ¹	Time-Delay ²	60	50	25	20	90	70	40	30	110	60	45
		Normal Operating ³	70	60	30	25	110	90	45	40	150	70
Min Input Conductor Size In AWG/Kcmil	8	8	10	12	4	6	8	10	3	8	8	
Max Recommended Input Conductor Length In Feet (Meters)	111 (34)	147 (45)	393 (120)	374 (114)	163 (50)	142 (43)	366 (112)	379 (115)	166 (51)	228 (70)	357 (109)	
Min Grounding Conductor Size In AWG/Kcmil	8	10	10	12	6	8	10	10	6	8	10	

Reference: 1999 National Electrical Code (NEC)

1 Consult factory for circuit breaker applications.

2 "Time-Delay" fuses are UL class "RK5".

3 "Normal Operating" (general purpose - no intentional delay) fuses are UL class "K5" (up to and including 60 amp), and UL class "H" (65 amp and above).

50 Hertz Models	300 Amp Model			450 Amp Model			650 Amp Model			
Input Voltage	380	400	440	380	400	440	380	400	440	
Input Amperes At Rated Output	27	25	23	39	37	33	58	54	50	
Max Recommended Standard Fuse Rating In Amperes ¹	Time-Delay ²	30	30	25	45	45	40	70	60	60
		Normal Operating ³	40	35	35	60	50	50	90	80
Min Input Conductor Size In AWG/Kcmil	10	10	10	8	8	8	6	6	6	
Max Recommended Input Conductor Length In Feet (Meters)	268 (82)	297 (90)	359 (109)	250 (76)	277 (84)	335 (102)	243 (74)	269 (82)	325 (99)	
Min Grounding Conductor Size In AWG/Kcmil	10	10	10	10	10	10	8	8	8	



Reference: 1999 National Electrical Code (NEC)

1 Consult factory for circuit breaker applications.

2 "Time-Delay" fuses are UL class "RK5".

3 "Normal Operating" (general purpose - no intentional delay) fuses are UL class "K5" (up to and including 60 amp), and UL class "H" (65 amp and above).

3-10. Remote 14 Receptacle RC8 And Terminal Strip 1T Information

	Socket	Terminal	Information
24 VOLTS AC  OUTPUT (CONTACTOR)	A	A	24 volts ac. Protected by circuit breaker CB2.
	B	B	Contact closure to A completes 24 volts ac contactor control circuit.
REMOTE OUTPUT CONTROL	C	C	Command reference; 0 to +10 volts dc.
	D	D	Remote control circuit common.
	E	E	0 to +10 volts dc input command signal from remote control.
A/V AMPERAGE VOLTAGE	F	*	Current feedback; 0 to +10 volts dc, 1 volt per 100 amperes.
	H	*	Voltage feedback; 0 to +10 volts dc, 1 volt per 10 arc volts.
115 VOLTS AC  OUTPUT (CONTACTOR)	I	I	115 volts, 15 amperes, 60 Hz ac. Protected by circuit breaker CB1.
	J	J	Contact closure to I completes 115 volts ac contactor control circuit.
GND	K	K	Chassis common.
	G	*	Circuit common for 24 and 115 volts ac circuits.
REMOTE POWER ON/OFF	*	L	To remote On/Off switch.
	*	M	
REMOTE VOLTAGE SENSING	*	N	Voltage sensing signal from Negative (-) weld output terminal.
	*	P	Voltage sensing signal from Positive (+) weld output terminal.

* Not Used

3-11. Remote 14 Receptacle RC8 And Terminal Strip 1T Connections



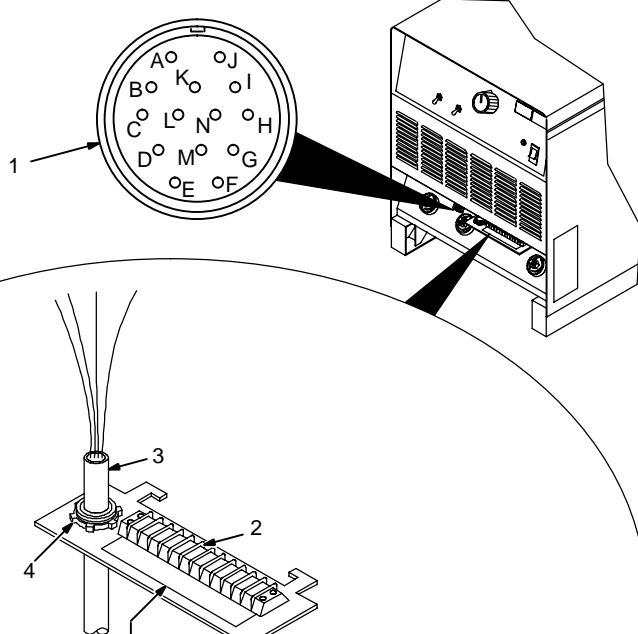

- 1 Remote 14 Receptacle RC8
Connect feeder to RC8. If feeder plug does not fit RC8, wire cord to terminal strip 1T.
- ▲ Turn Off power before opening terminal strip cover.**
- 2 Terminal Strip 1T
- 3 Feeder Or Remote On/Off Switch Cord
- 4 Strain Relief (Customer Supplied)

Secure cord in strain relief. Reinstall and secure access panel. Close door.

C	E	D	I	J	A	B	N	P	K	M	L
REMOTE OUTPUT CONTROL		115 VAC REMOTE CONTACTOR		24VAC REMOTE CONTACTOR		REMOTE VOLTAGE SENSE		GND	REMOTE POWER ON/OFF		

S-162 895-B

Ref. ST-800 451 / Ref. S-0004-A / Ref. ST-800 451-C

3-12. Placing Jumper Links And Connecting Input Power

200 VOLTS

230 VOLTS

460 VOLTS

Ref. S-174 976-A

230 VOLTS

460 VOLTS

575 VOLTS

Ref. S-174 973-A

220 VOLTS
(FACTORY OPTION)

380 VOLTS

400 VOLTS

440 VOLTS

Ref. S-174 975-A

GND/PE
Earth
Ground

4

L1 (U)
L2 (V)
L3 (W)

3

Connect GND/PE
Conductor First.

2

Do not overtighten
jumper link nuts.

IMPORTANT

L1 (U)

L2 (V)

L3 (W)

GND/PE

3 ~
Input Contactor

Connect GND/PE
Conductor First.

Tools Needed:

- 3/8 in
- 3/8 in
-

Check input voltage available at site.

1 Jumper Link Label

Check label – only one is on unit.

2 Jumper Links

Move jumper links to match input voltage.

3 Input And Grounding Conductors
See Section 3-9.

4 Line Disconnect Device
See Section 3-9.

5 Reed Switch (Ground Current Sensor)
(Optional)

6 Grounding Conductor

If unit is equipped with optional ground current sensor, route grounding conductor through reed switch two times and connect to ground terminal.

Close access door.

SECTION 4 – OPERATION

4-1. Controls (Non CE Models)

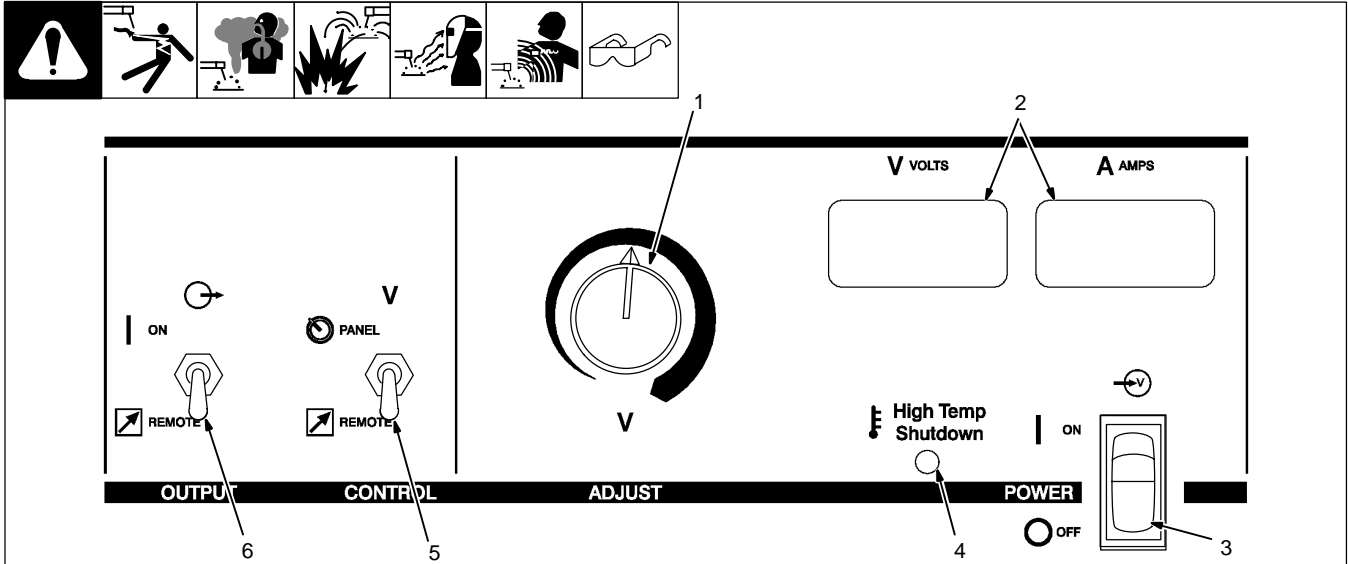

Ref. ST-162 503-C

1 Voltage Adjustment Control

Turn control clockwise to increase voltage. Voltmeter value changes as control knob is turned. Control can be adjusted while welding.

2 Digital Meters

Voltmeter displays preset voltage with contactor off. Voltmeter and ammeter display actual output voltage and amperage with contactor on.

3 Power Switch With Indicator Light

For front panel control, place switch in Panel position. For remote control, place switch in Remote position, and connect remote device (see Section 3-11).

4 High Temperature Shutdown Light

For front panel control, place switch in Panel position. For remote control, place switch in Remote position, and connect remote device (see Section 3-11).

6 Output Switch

For front panel control of output, place switch in Panel position. For remote control of output, place switch in Remote position, and connect remote device (see Section 3-11).

▲ **Weld output studs are energized only when Output switch is in On position, or while welding.**

▲ **Turn Off power before connecting remote device.**

4-2. Controls (CE Models)

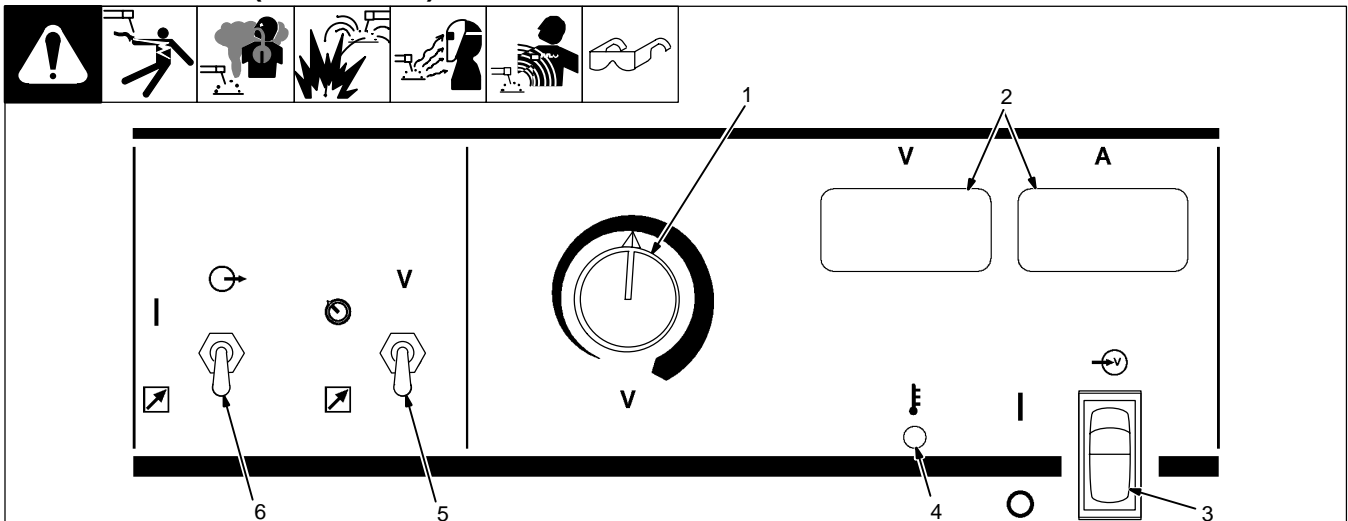

Ref. ST-173 449-B

1 Voltage Adjustment Control

Turn control clockwise to increase voltage. Voltmeter value changes as control knob is turned. Control can be adjusted while welding.

2 Digital Meters

Voltmeter displays preset voltage with contactor off. Voltmeter and ammeter display actual output voltage and amperage with contactor on.

3 Power Switch With Indicator Light

For front panel control, place switch in Panel position. For remote control, place switch in Remote position, and connect remote device (see Section 3-11).

6 Output Switch

For front panel control of output, place switch in Panel position. For remote control of output, place switch in Remote position, and connect remote device (see Section 3-11).

▲ **Weld output studs are energized only when Output switch is in On position, or while welding.**

▲ **Turn Off power before connecting remote device.**

SECTION 5 – MAINTENANCE & TROUBLESHOOTING

5-1. Routine Maintenance

			▲ Disconnect power before maintaining.
--	--	--	---

	3 Months		Replace unreadable labels.			Repair or replace cracked weld cable.		Clean and tighten weld terminals.
	6 Months							Blow out or vacuum inside. During heavy service, clean monthly

5-2. Fuse F1

			▲ Turn Off power before opening rear access door.
			<ol style="list-style-type: none">1 Fuse Holder Cover2 Fuse F1 (See Parts List For Rating)
			Fuse F1 protects control transformer from overload. If F1 opens, weld output and fan motor stops. Replace F1.
Tools Needed:		3/8 in	
			Ref. ST-800 101-C

5-3. Short Circuit Shutdown

When contact tip is shorted and sticks to workpiece, the unit output falls to a safe operating level. To resume operation, release gun trigger, turn Off unit, and remove contact tip from workpiece. Check contact tip and replace if damaged. Turn On unit to continue operation.

5-4. Troubleshooting Table



Trouble	Remedy
No weld output; unit completely inoperative.	Place line disconnect switch in On position (see Section 3-12).
	Check fuse F1, and replace if necessary (see Section 5-2).
	Check and replace line fuse(s), if necessary, or reset circuit breaker (see Section 3-12).
	Check for proper input power connections (see Section 3-12).
	Check for proper jumper link position (see Section 3-12).
No weld output; Power switch pilot light on; fan on.	If using wire feeder, place Output (Contactor) switch in Remote 14 position, and connect wire feeder (see Sections 3-10 and 3-11). If feeder is not being used, place switch in On position (see Section 4-1).
	Check, repair, or replace feeder (see wire feeder Owner's Manual).
	Unit overheated. Allow unit to cool with fan On (see Section 3-2).
	Have Factory Authorized Service Agent check control board PC1.
Unit provides only maximum or minimum weld output.	Have Factory Authorized Service Agent check control board PC1.
Erratic or improper weld output.	Use proper size and type of weld cable (see Section 3-8).
	Clean and tighten all weld connections.
	Check wire feeder installation according to Owner's Manual.
	Have Factory Authorized Service Agent check control board PC1 and/or SCR in main rectifier.
No 115 volts ac output at duplex receptacle, Remote 14 receptacle, or terminal strip 1T.	Reset circuit breaker CB1 (see Section 3-7).
No 24 volts ac output at Remote 14 receptacle, or terminal strip 1T.	Reset circuit breaker CB2 (see Section 3-7).
Fan not operating. Note: fan runs only when cooling is necessary.	Check for and remove anything blocking fan movement.
	Have Factory Authorized Service Agent check fan motor.

SECTION 6 – ELECTRICAL DIAGRAM

For Primary Circuit Diagram Portion, refer to Circuit Diagram located inside wrapper of welding power source.

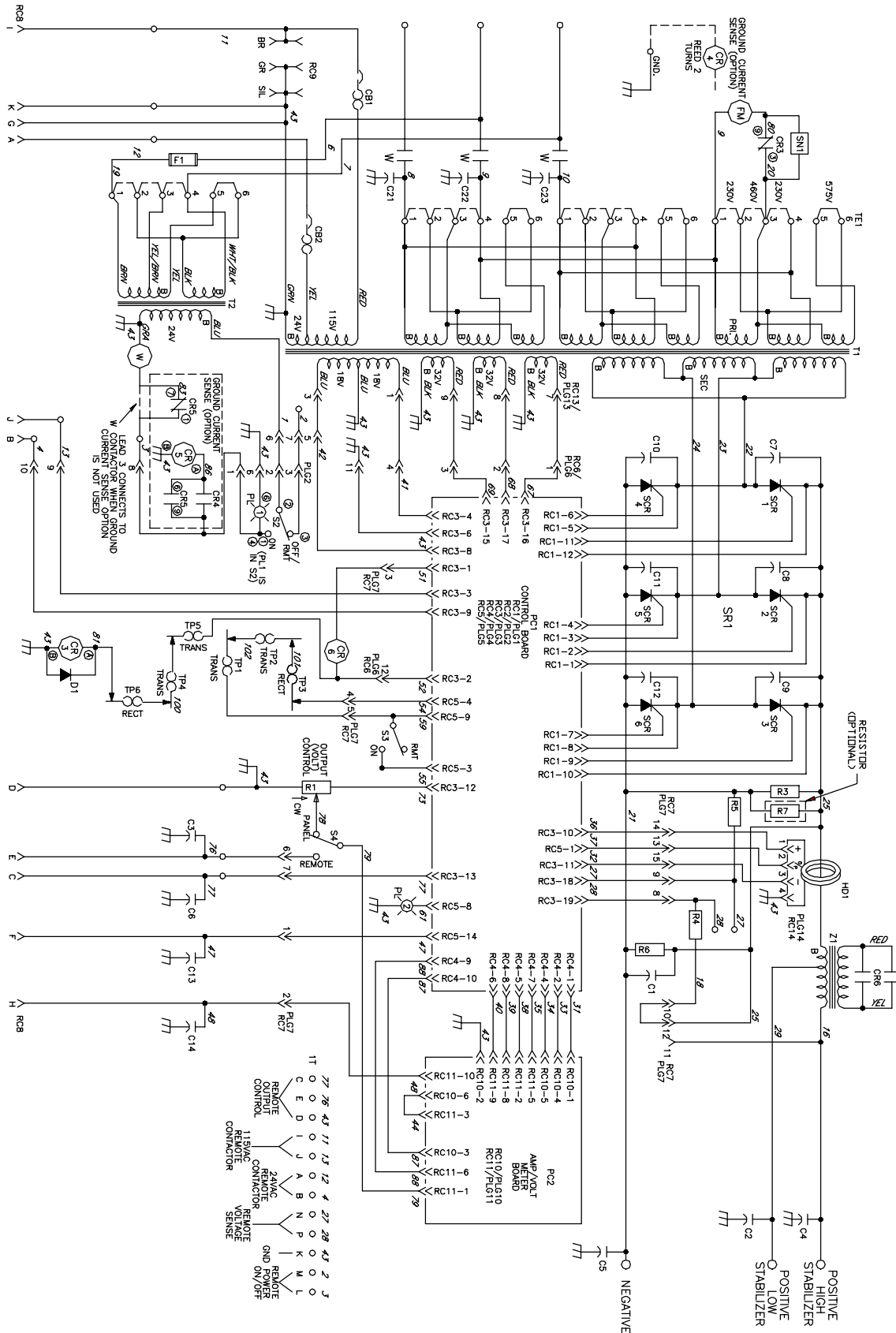

WARNING

ELECTRIC SHOCK HAZARD

- Do not touch live electrical parts.
- Disconnect input power or stop engine before servicing.
- Do not operate with covers removed.
- Have only qualified persons install, use, or service this unit.

Figure 6-1. Circuit Diagram

SECTION 7 – PARTS LIST

 Hardware is common and not available unless listed.

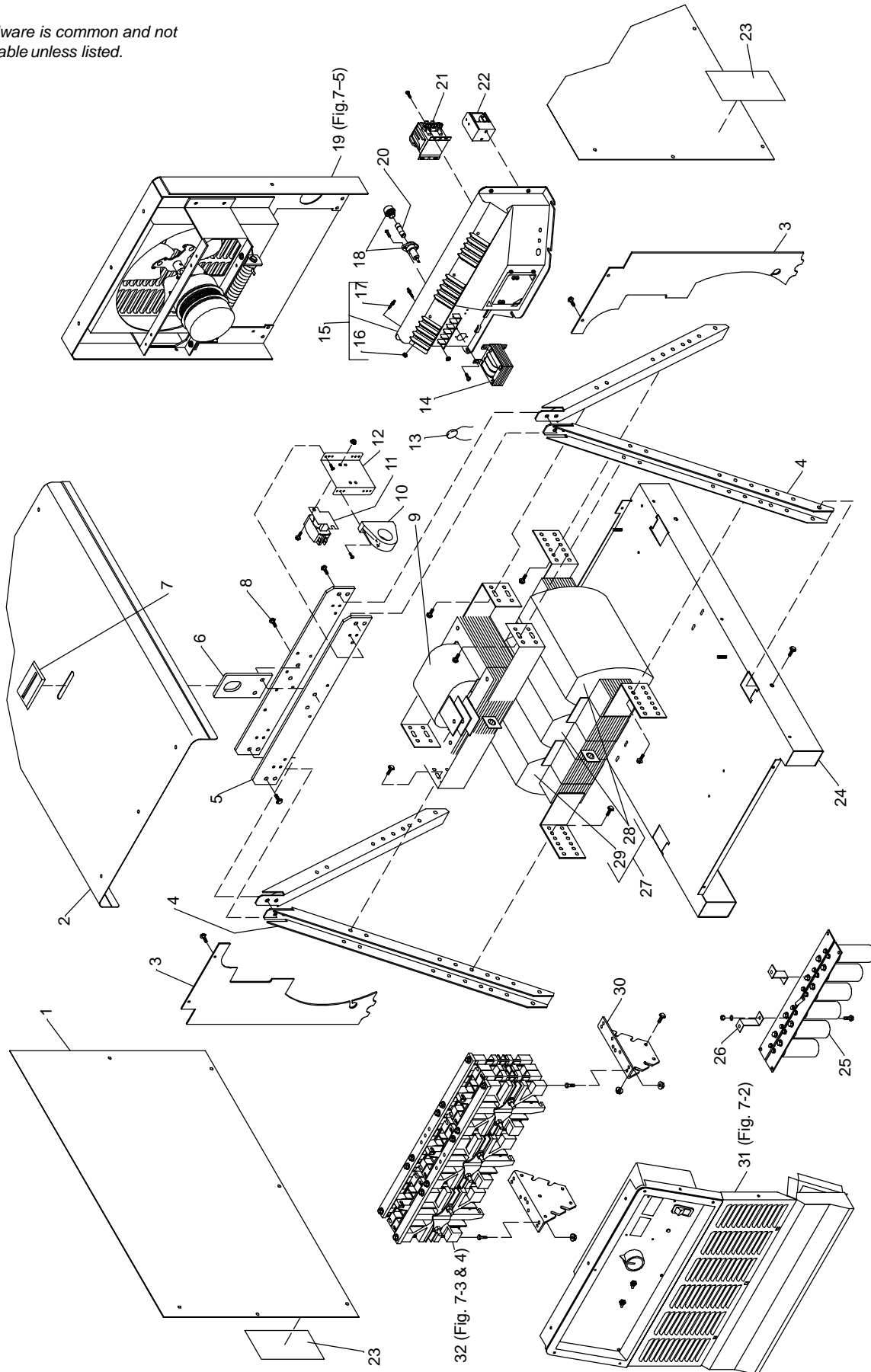

Figure 7-1 Main Assembly (452 Model Illustrated)

ST-800 992-F

Item No.	Dia. Mkgs.	Part No.	Description	Quantity		
				302	452	652
Figure 7-1 Main Assembly (452 Model Illustrated)						
1		+179 430	PANEL, side	2		
1		+179 432	PANEL, side		2	2
2		179 429	COVER, top	1		
2		179 431	COVER, top		1	1
3		164 699	BAFFLE, air	2	2	
3		164 903	BAFFLE, air			2
4		162 816	CHANNEL, upright	4	4	4
5		162 820	BAR, mtg lift eye	2	2	2
6		162 830	LIFT EYE	1	1	1
7		177 279	GASKET, lift eye	1	1	1
8		604 536	SCREW, .312-18 x 1.75 hexhd-pln gr 5	2	2	2
9	Z1	166 362	STABILIZER	1		
9	Z1	166 364	STABILIZER		1	
9	Z1	180 066	STABILIZER			1
		164 717	BUS BAR, stabilizer			1
10	HD1	168 829	TRANSDUCER, current 1000A	1	1	1
11	CR6	160 966	CONTACTOR, def prp 25A 2P 24VDC	1	1	1
12		173 605	BRACKET, mtg contactor	1	1	1
13	C21-23	163 906	CAPACITOR, 50 and 60Hz	3	3	3
14	T2	159 042	TRANSFORMER, control 50VA 24V 230/460/575 (60Hz)	1	1	1
14	T2	159 041	TRANSFORMER, control 50VA 24V 200/230/460 (60Hz)		1	
14	T2	159 043	TRANSFORMER, control 50VA 24V (50Hz)	1	1	1
15	TE1	159 244	PRIMARY BOX, (consisting of)	1	1	1
16		601 835	NUT, 10-32 brs	24	24	24
17		038 887	STUD, pri bd brs 10-32 x 1.375	24	24	24
		010 913	WASHER, flat .218 ID brs	24	24	24
		601 835	NUT, 10-32 brs	24	24	24
		038 618	LINK, jumper term bd pri	8	8	8
18		159 034	HOLDER, fuse mintr	1	1	1
19		Fig 7-5	PANEL, rear w/components	1	1	1
20	F1	*156 065	FUSE, crtg .5A 600V time delay	1	1	1
21	W	160 760	CONTACTOR, def prp 40A 3P 24VAC	1		
21	W	160 793	CONTACTOR, def prp 60A 3P 24VAC		1	
21	W	160 794	CONTACTOR, def prp 75A 3P 24V			1
22	CR4	◆140 750	SWITCH, reed	1	1	1
23		134 464	LABEL, warning general precautionary	2	2	2
24		163 533	BASE	1		
24		163 359	BASE		1	1
25	C1	182 661	CAPACITOR ASSEMBLY, (consisting of)	1	1	1
		163 535	CAPACITOR, elctlt 16000uf 60VDC	6	6	6
	R6	140 002	RESISTOR, WW fxd 10W 500 ohm	1	1	1
		162 817	BUS BAR, capacitor	2	2	2
26		182 660	BUS BAR, mtg capacitor		4	4
		162 799	BRACKET, mtg capacitor	2		
27	T1	189 832	TRANSFORMER, pwr main 200/230/460 (consisting of)	1		
28		166 439	COIL, pri/sec 200/230/460 (center & RH)	2		
29		166 438	COIL, pri/sec 200/230/460 (LH)	1		
27	T1	189 833	TRANSFORMER, pwr main 230/460/575 (consisting of)	1		
28		172 303	COIL, pri/sec 230/460/575 (center & RH)	2		
29		172 302	COIL, pri/sec 230/460/575 (LH)	1		
27	T1	189 835	TRANSFORMER, pwr main 200/230/460 (consisting of)		1	
28		166 442	COIL, pri/sec 200/230/460 (center & RH)		2	
29		166 441	COIL, pri/sec 200/230/460 (LH)		1	
27	T1	189 836	TRANSFORMER, pwr main 230/460/575 (consisting of)		1	
28		172 309	COIL, pri/sec 230/460/575 (center & RH)		2	
29		172 308	COIL, pri/sec 230/460/575 (LH)		1	

Item No.	Dia. Mkgs.	Part No.	Description	Quantity		
				Model		
				302	452	652
Figure 7-1 Main Assembly (452 Model Illustrated) (continued)						
... 27	... T1	... 189 839	.. TRANSFORMER, pwr main 230/460/575 (consisting of)	1
... 28 172 315	... COIL, pri/sec 230/460/575 (center & RH)	2
... 29 172 314	... COIL, pri/sec 230/460/575 (LH)	1
... 27	... T1	... 189 834	.. TRANSFORMER, pwr main 380/400/440 (consisting of)	1
... 28 172 421	... COIL, pri/sec (center & RH)	2
... 29 172 420	... COIL, pri/sec (LH)	1
... 27	... T1	... 189 837	.. TRANSFORMER, pwr main 380/400/440 (consisting of)	1
... 28 172 427	... COIL, pri/sec (center & RH)	2
... 29 172 426	... COIL, pri/sec (LH)	1
... 27	... T1	... 189 838	.. TRANSFORMER, PWR MAIN 380/400/440 (consisting of)	1
... 28 172 433	... COIL, pri/sec (center & RH)	2
... 29 172 432	... COIL, pri/sec (LH)	1
...	TP1,2	... 175 405	.. THERMOSTAT, NC (Included w/T1)	2	2	2
...	TP4,5	... 168 891	.. THERMOSTAT, NC (Included w/T1)	2	2	2
...	PLG13	... 189 873	.. CONNECTOR & PINS	1	1	1
...	RC13	... 189 874	.. CONNECTOR & SOCKETS	1	1	1
...	PLG6	... 168 847	.. CONNECTOR & SOCKETS	1	1	1
...	RC6	... 168 845	.. CONNECTOR & PINS	1	1	1
... 30 161 294	.. BRACKET, mtg rectifier	2	2	2
... 31	...	Fig 7-2	.. PANEL, front w/components	1	1	1
... 32	SR1	... 175 070	.. RECTIFIER, si diode (Fig 7-3)	1		
... 32	SR1	... 192 672	.. RECTIFIER, SCR main (Fig 7-4)		1	
... 32	SR1	... 192 671	.. RECTIFIER, SCR main (Fig 7-4)			1
...	PLG14	... 115 094	.. CONNECTOR & SOCKETS	1	1	1
...	PLG7	... 152 249	.. CONNECTOR & PINS	1	1	1
...	RC7	... 168 846	.. CONNECTOR & SOCKETS	1	1	1
... 010 467	.. CONNECTOR, clamp cable 1.250	1	1	1
...	R7	◆◆ 114 808	.. RESISTOR, WW fxd 375W 5 ohm	1	1	1

◆ Part of Option 042 983 Ground Current Sensor

◆◆ Part of Option 043 286 Additional Resistor

+When ordering a component originally displaying a precautionary label, the label should also be ordered.

*Recommended Spare Parts.

To maintain the factory original performance of your equipment, use only Manufacturer's Suggested Replacement Parts. Model and serial number required when ordering parts from your local distributor.

Item No.	Dia. Mkgs.	Part No.	Description	Quantity		
				302	452	652

Figure 7-2 Panel, Front w/Components (Fig 7-1 Item 33)

1		159 863	ELECTRONICS BOX	1	1	1
2	PC1	185 583	CIRCUIT CARD, control (60Hz)	1		
2	PC1	186 424	CIRCUIT CARD, control (60Hz)		1	
2	PC1	186 427	CIRCUIT CARD, control (60Hz)			1
2	PC1	186 422	CIRCUIT CARD, control (50Hz)	1		
2	PC1	186 426	CIRCUIT CARD, control (50Hz)		1	
2	PC1	186 428	CIRCUIT CARD, control (50Hz)			1
	PLG1	158 720	CONNECTOR & SOCKETS, (see Fig 7-3 & 4)			
	PLG3	169 240	CONNECTOR & SOCKETS	1	1	1
	PLG4	148 439	CONNECTOR & SOCKETS	1	1	1
	PLG5	152 249	CONNECTOR & SOCKETS	1	1	1
3	CR3	052 964	RELAY, encl 24VDC DPDT	1	1	1
4	CR5	◆006 393	RELAY, encl 24VAC DPDT	1	1	1
5	CB1,2	093 995	CIRCUIT BREAKER, man reset 1P 15A 250VAC	2	2	2
6	RC9	604 176	RECEPTACLE, str dx grd 2P3W 15A 125V	1	1	1
7		163 855	CONNECTOR/CAPACITOR, w/leads (consisting of)	1	1	1
	RC8	143 976	CONNECTOR & SOCKETS	1	1	1
	C3	163 863	LEAD ASSEMBLY, elect	1	1	1
	C6	163 861	LEAD ASSEMBLY, elect	1	1	1
	C13	163 858	LEAD ASSEMBLY, elect	1	1	1
	C14	163 857	LEAD ASSEMBLY, elect	1	1	1
8		162 802	PANEL, front	1	1	1

Hardware is common and not available unless listed.

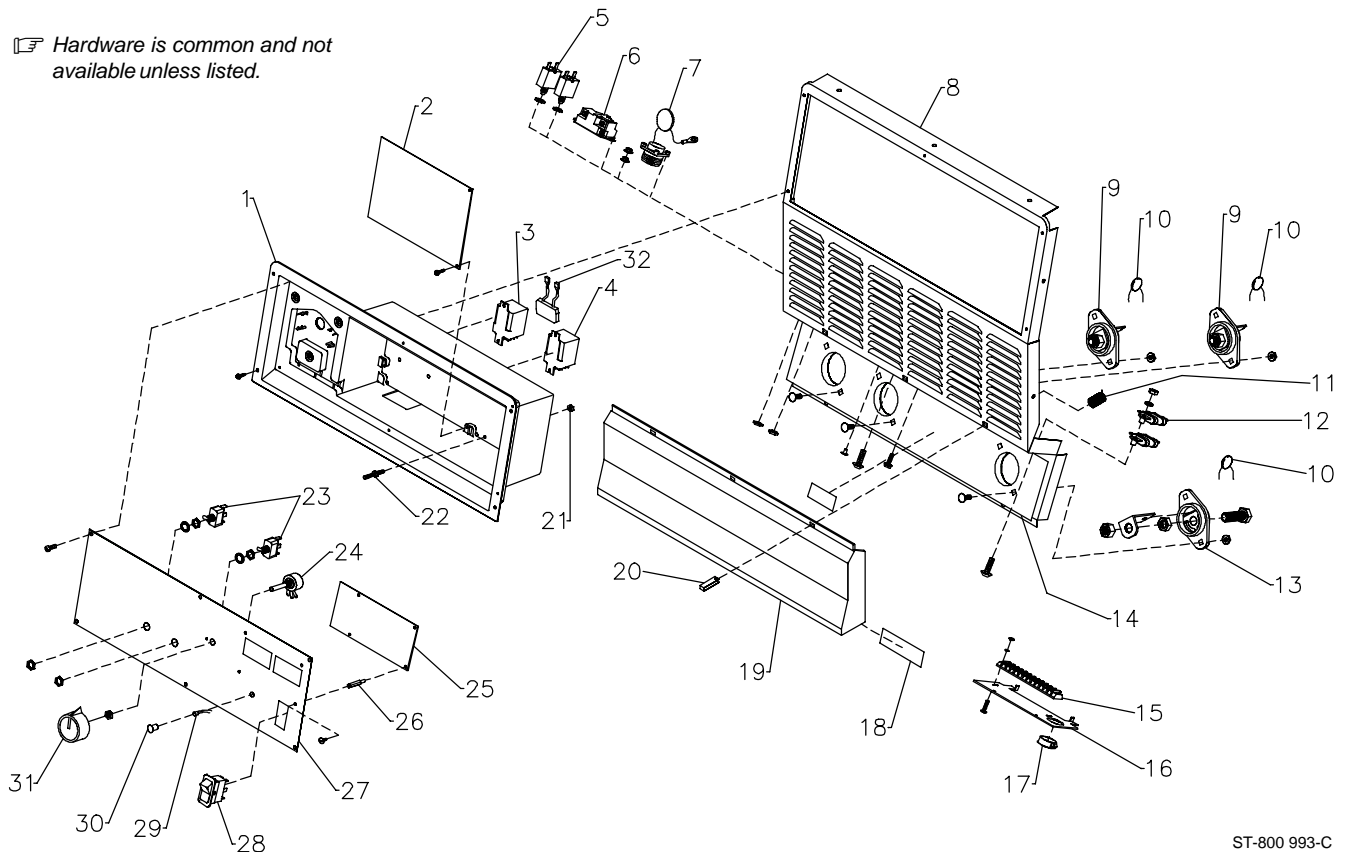

ST-800 993-C

Figure 7-2 Panel, Front w/Components (452 Model Illustrated)

Item No.	Dia. Mkgs.	Part No.	Description	Quantity		
				Model	302	452
Figure 7-2 Panel, Front w/Components (Fig 7-1 Item 33)						
(continued)						
...	9	POS	181 245	..	TERMINAL, pwr output red	2 ... 2 ... 2
...	10	C2,4,5	128 750	..	CAPACITOR, cer disc .1uf 500VDC	3 ... 3 ... 3
...	11		161 303	..	SPRING, cprsn .600 OD x .072 wire x 1.500 lg	3 ... 3 ... 3
...	12	R4,5	136 076	..	RESISTOR, WW fxd 30W 200 ohm	2 ... 2 ... 2
...	13	NEG	181 246	..	TERMINAL, pwr output black	1 ... 1 ... 1
...	14		174 936	..	PLATE, control lower	1 ... 1 ... 1
...	15	1T	159 040	..	BLOCK, term 20A 12P	1 ... 1 ... 1
...	16		162 828	..	PANEL, mtg rcpt/terminal strip	1 ... 1 ... 1
...	17		070 371	..	BLANK, snap-in nyl 1.093/1.125mtg hole	1 ... 1 ... 1
...	18		162 891	..	LABEL, warning electric shock	1 ... 1 ... 1
...	19		+172 587	..	COVER, stud output	1 ... 1 ... 1
...	20		160 935	..	CLIP, spring	3 ... 3 ... 3
...	21		601 835	..	NUT, 10-32 brs	2 ... 2 ... 2
...			010 913	..	WASHER, flat .218 ID x .460 OD x .031thk brs	1 ... 1 ... 1
...	22		038 887	..	STUD, pri bd brs 10-32 x 1.375	1 ... 1 ... 1
...	23	S3,4	011 609	..	SWITCH, tgl SPDT 15A 125VAC	2 ... 2 ... 2
...	24	R1	035 897	..	POTENTIOMETER, CP std slot 1/T 2W 1K ohm	1 ... 1 ... 1
...	25	PC2	178 130	..	CIRCUIT CARD, digital meter	1
...	25	PC2	177 909	..	CIRCUIT CARD, digital meter	1
...	25	PC2	178 131	..	CIRCUIT CARD, digital meter	1
...		PLG10	153 501	..	CONNECTOR & SOCKETS	1 ... 1 ... 1
...		PLG11	148 439	..	CONNECTOR & SOCKETS	1 ... 1 ... 1
...	26		192 174	..	STAND-OFF	4 ... 4 ... 4
...	27			..	NAMEPLATE, (order by model and serial number)	1 ... 1 ... 1
...	28	S2	159 039	..	SWITCH, rocker SPDT 15A 125VAC	1 ... 1 ... 1
...		PLG2	185 626	..	CONNECTOR, body 56 series	1 ... 1 ... 1
...	29	PL2	159 522	..	LED, yellow	1 ... 1 ... 1
...	30		159 036	..	LENS, LED clear	1 ... 1 ... 1
...	31		097 924	..	KNOB, pointer	1 ... 1 ... 1
...	32	SN1	197 868	..	SNUBBER, assy	1 ... 1 ... 1

◆Part of Option 042 983 Ground Current Sensor

+When ordering a component originally displaying a precautionary label, the label should also be ordered.

To maintain the factory original performance of your equipment, use only Manufacturer's Suggested Replacement Parts. Model and serial number required when ordering parts from your local distributor.

Item No.	Dia. Mkgs.	Part No.	Description	Quantity
SR1 175 070 Figure 7-3 Rectifier, Si Diode (302 Model) (Fig 7-1 Item 34)				
1	C7-12	048 420	CAPACITOR, cer disc .01uf 1000VDC	6
2		177 316	HEAT SINK, rect	3
3		177 317	HEAT SINK, rect	2
4		166 667	CLAMP, thyristor rect	3
5	TP3	185 679	THERMOSTAT, NC	1
6	TP6	185 680	THERMOSTAT, NC	1
7	SCR1-6	161 668	THYRISTOR, SCR 300A 300V hockey puck	6
	PLG1	158 720	CONNECTOR & SOCKETS	1
8		188 692	CLAMP, thyristor rectifier 4.250	3

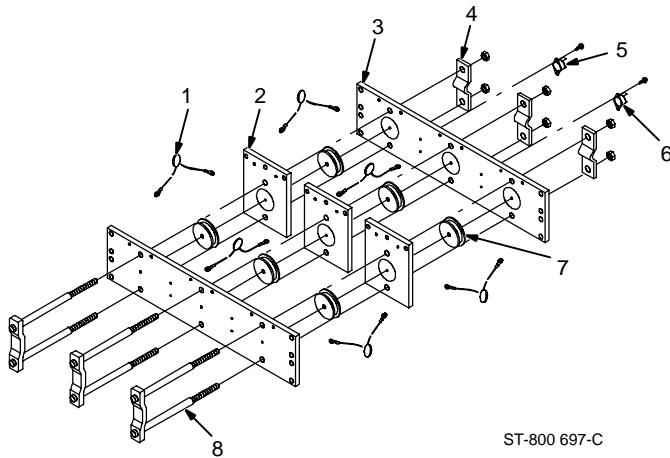

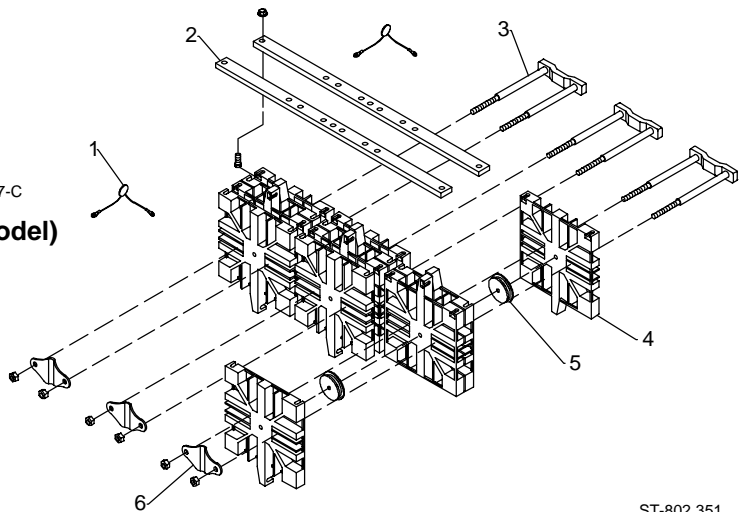

Figure 7-3 Rectifier, Si Diode SR1 (302 Model)

ST-800 697-C

 Hardware is common and not available unless listed.



ST-802 351

Figure 7-4 Rectifier, SCR Main SR1 (452 & 652 Model)

Item No.	Dia. Mkgs.	Part No.	Description	Quantity
SR1 Figure 7-4 Rectifier, SCR Main (452 & 652 Model) (Fig 7-1 Item 34)				
				192 672 192 671
1	C7-12	048 420	CAPACITOR, cer disc .01uf 1000VDC	6
2		191 989	BAR, mtg rectifier	2
3		188 691	CLAMP, thyristor rectifier 5.375	3
4		188 839	HEAT SINK, rectifier snowflake .800	12
5	SCR1-6	161 668	THYRISTOR, SCR 300A 300V hockey puck	6
5	SCR1-6	148 091	THYRISTOR, SCR 865A 300V hockey puck	6
6		166 667	CLAMP, spring thyristor rectifier 5.500	3
	PLG1	158 720	CONNECTOR & SOCKETS	1
	TP3	192 673	THERMOSTAT, rectifier	1
	TP6	192 674	THERMOSTAT, rectifier	1

To maintain the factory original performance of your equipment, use only Manufacturer's Suggested Replacement Parts. Model and serial number required when ordering parts from your local distributor.

Item No.	Dia. Mkgs.	Part No.	Description	Quantity
----------	------------	----------	-------------	----------

Figure 7-5 Panel, Rear w/Components (Fig 7-1 Item 19)

...	1	173 283	.. CHAMBER, plenum 14 in	1
...	2	180 165	.. BLADE, fan 14 in 3wg 28deg .375 bore CCW	1
...	3	162 807	.. PANEL, rear	1
...	4	168 343	.. HINGE, door primary	2
...	5	+162 818	.. DOOR, access primary	1
...	6	168 384	.. LABEL, warning electric shock	1
...	7	602 177	.. SCREW, set .250-20 x .250knrlpt sch stl	2
...	8	124 274	.. BRACKET, mtg fan motor	1
...	9	R3	.. RESISTOR, WW fxd 375W 5 ohm	1
...	10	FM	.. MOTOR, 1/12HP 230V 1550RPM 50/60Hz 1.5A	1
.....		010 467	.. CONNECTOR, clamp cable 1.250	1

 Hardware is common and not available unless listed.

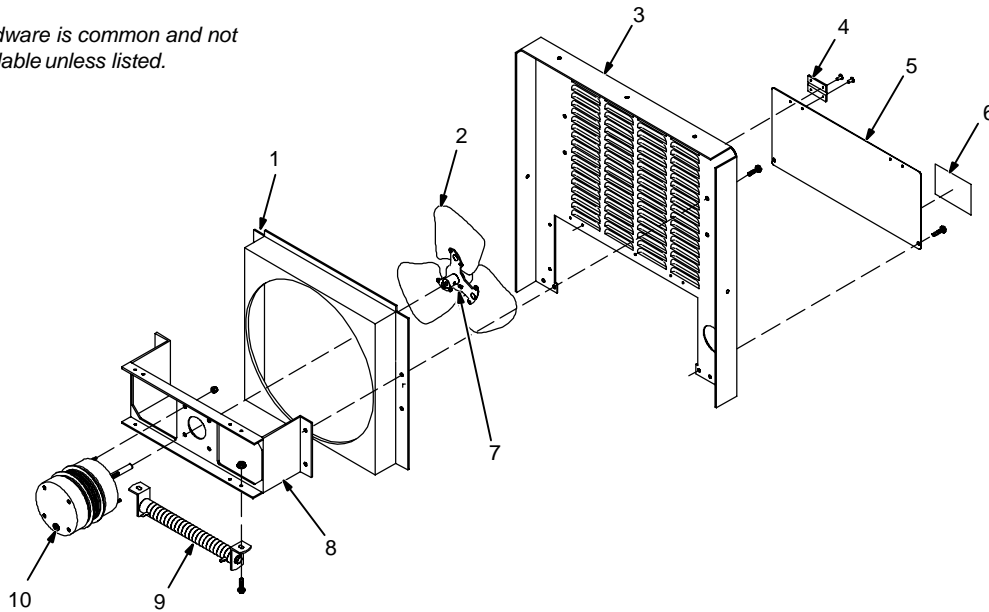

ST-800 707-A

Figure 7-5 Panel, Rear w/Components

+When ordering a component originally displaying a precautionary label, the label should also be ordered.
To maintain the factory original performance of your equipment, use only Manufacturer's Suggested Replacement Parts. Model and serial number required when ordering parts from your local distributor.

HOBART WARRANTY

Effective January 1, 2000

(Equipment with a serial number preface of "LA" or newer)

This limited warranty supersedes all previous Hobart warranties and is exclusive with no other guarantees or warranties expressed or implied.

Warranty Questions?

Call

1-877-HOBART1

for your local
Hobart distributor.

Service

You always get the fast, reliable response you need. Most replacement parts can be in your hands in 24 hours.

Support

Need fast answers to the tough welding questions? Contact your distributor or call 1-800-332-3281. The expertise of the distributor and Hobart is there to help you, every step of the way.

LIMITED WARRANTY – Subject to the terms and conditions below, Hobart Welding Products., Troy, Ohio, warrants to its original retail purchaser that new Hobart equipment sold after the effective date of this limited warranty is free of defects in material and workmanship at the time it is shipped by Hobart. THIS WARRANTY IS EXPRESSLY IN LIEU OF ALL OTHER WARRANTIES, EXPRESS OR IMPLIED, INCLUDING THE WARRANTIES OF MERCHANTABILITY AND FITNESS.

Within the warranty periods listed below, Hobart will repair or replace any warranted parts or components that fail due to such defects in material or workmanship. Hobart must be notified in writing within thirty (30) days of such defect or failure, at which time Hobart will provide instructions on the warranty claim procedures to be followed.

Hobart shall honor warranty claims on warranted equipment listed below in the event of such a failure within the warranty time periods. All warranty time periods start on the date that the equipment was delivered to the original retail purchaser, or one year after the equipment is sent to a North American distributor or eighteen months after the equipment is sent to an International distributor.

1. 5 Years Parts – 3 Years Labor
 - * Original main power rectifiers
 - * Inverters (input and output rectifiers only)
2. 3 Years — Parts and Labor
 - * Transformer/Rectifier Power Sources
 - * Plasma Arc Cutting Power Sources
 - * Semi-Automatic and Automatic Wire Feeders
 - * Inverter Power Supplies
 - * Intelligig
 - * Engine Driven Welding Generators
(NOTE: Engines are warranted separately by the engine manufacturer.)
3. 1 Year — Parts and Labor
 - * DS-2 Wire Feeder
 - * Motor Driven Guns (w/exception of Spoolmate 185 & Spoolmate 250)
 - * Process Controllers
 - * Positioners and Controllers
 - * Automatic Motion Devices
 - * RFCS Foot Controls
 - * Induction Heating Power Sources
 - * Water Coolant Systems
 - * HF Units
 - * Grids
 - * Maxstar 140
 - * Spot Welders
 - * Load Banks
 - * Hobart Cyclomatic Equipment
 - * Running Gear/Trailers
 - * Plasma Cutting Torches (except APT & SAF Models)
 - * Field Options
(NOTE: Field options are covered under True Blue® for the remaining warranty period of the product they are installed in, or for a minimum of one year — whichever is greater.)
4. 6 Months — Batteries
5. 90 Days — Parts
 - * MIG Guns/TIG Torches
 - * Induction Heating Coils and Blankets

- * APT, ZIPCUT & PLAZCUT Model Plasma Cutting Torches
- * Remote Controls
- * Accessory Kits
- * Replacement Parts (No labor)
- * Spoolmate 185 & Spoolmate 250
- * Canvas Covers

HOBART's Limited Warranty shall not apply to:

1. **Consumable components; such as contact tips, cutting nozzles, contactors, brushes, slip rings, relays or parts that fail due to normal wear.**
2. Items furnished by Hobart, but manufactured by others, such as engines or trade accessories. These items are covered by the manufacturer's warranty, if any.
3. Equipment that has been modified by any party other than Hobart, or equipment that has been improperly installed, improperly operated or misused based upon industry standards, or equipment which has not had reasonable and necessary maintenance, or equipment which has been used for operation outside of the specifications for the equipment.

HOBART PRODUCTS ARE INTENDED FOR PURCHASE AND USE BY COMMERCIAL/INDUSTRIAL USERS AND PERSONS TRAINED AND EXPERIENCED IN THE USE AND MAINTENANCE OF WELDING EQUIPMENT.

In the event of a warranty claim covered by this warranty, the exclusive remedies shall be, at Hobart's option: (1) repair; or (2) replacement; or, where authorized in writing by Hobart in appropriate cases, (3) the reasonable cost of repair or replacement at an authorized Hobart service station; or (4) payment of or credit for the purchase price (less reasonable depreciation based upon actual use) upon return of the goods at customer's risk and expense. Hobart's option of repair or replacement will be F.O.B., Factory at Appleton, Wisconsin, or F.O.B. at a Hobart authorized service facility as determined by Hobart. Therefore no compensation or reimbursement for transportation costs of any kind will be allowed.

TO THE EXTENT PERMITTED BY LAW, THE REMEDIES PROVIDED HEREIN ARE THE SOLE AND EXCLUSIVE REMEDIES. IN NO EVENT SHALL HOBART BE LIABLE FOR DIRECT, INDIRECT, SPECIAL, INCIDENTAL OR CONSEQUENTIAL DAMAGES (INCLUDING LOSS OF PROFIT), WHETHER BASED ON CONTRACT, TORT OR ANY OTHER LEGAL THEORY.

ANY EXPRESS WARRANTY NOT PROVIDED HEREIN AND ANY IMPLIED WARRANTY, GUARANTY OR REPRESENTATION AS TO PERFORMANCE, AND ANY REMEDY FOR BREACH OF CONTRACT TORT OR ANY OTHER LEGAL THEORY WHICH, BUT FOR THIS PROVISION, MIGHT ARISE BY IMPLICATION, OPERATION OF LAW, CUSTOM OF TRADE OR COURSE OF DEALING, INCLUDING ANY IMPLIED WARRANTY OF MERCHANTABILITY OR FITNESS FOR PARTICULAR PURPOSE, WITH RESPECT TO ANY AND ALL EQUIPMENT FURNISHED BY HOBART IS EXCLUDED AND DISCLAIMED BY HOBART.

Some states in the U.S.A. do not allow limitations of how long an implied warranty lasts, or the exclusion of incidental, indirect, special or consequential damages, so the above limitation or exclusion may not apply to you. This warranty provides specific legal rights, and other rights may be available, but may vary from state to state.

In Canada, legislation in some provinces provides for certain additional warranties or remedies other than as stated herein, and to the extent that they may not be waived, the limitations and exclusions set out above may not apply. This Limited Warranty provides specific legal rights, and other rights may be available, but may vary from province to province.





Owner's Record

Please complete and retain with your personal records.

Model Name	Serial/Style Number
------------	---------------------

Purchase Date	(Date which equipment was delivered to original customer.)
---------------	--

Distributor

Address

City

State	Zip
-------	-----



Resources Available

Always provide Model Name and Serial/Style Number.

To locate a Distributor, retail or service location:

Call 1-877-Hobart1 or visit our website at www.HobartWelders.com

For technical assistance:

Call 1-800-332-3281

Contact your Distributor for:

- Welding Supplies and Consumables
- Options and Accessories
- Personal Safety Equipment
- Service and Repair
- Replacement Parts
- Training (Schools, Videos, Books)
- Technical Manuals (Servicing Information and Parts)
- Circuit Diagrams
- Welding Process Handbooks

Contact the Delivering Carrier for:

For assistance in filing or settling claims, contact your distributor and/or equipment manufacturer's Transportation Department.

File a claim for loss or damage during shipment.

Hobart Welding Products

An Illinois Tool Works Company
600 West Main Street
Troy, OH 45373 USA

For Technical Assistance:

Call 1-800-332-3281
For Literature Or Nearest Dealer:
Call 1-877-Hobart1